

The technical marine pneumatic experts

Teryair Marine Products Brochure

a comprehensive guide to teryair's IMPA Products

Who are we ?



Teryair: A leading manufacturer of pneumatic machinery for the marine industry.

Teryair was founded in 2002 by a team of innovative engineers with a passion for designing and manufacturing high-quality products for the marine industry. Teryair's products are used on a wide variety of vessels, including oil tankers, container ships, passenger ships, bulk carriers, naval vessels, and offshore vessels.

Teryair's products are manufactured in a modern factory in Mumbai, India. The factory is equipped with state-of-the-art machinery and is staffed by experienced engineers and technicians. Teryair's products are certified to the highest international standards, and the company has a long standing reputation for quality and reliability.

Teryair's customers include some of the world's leading vessel owners and management companies. The company's products are also sold through a network of authorized distributors around the world.

Teryair is committed to providing its customers with the best possible products and services. The company offers a wide range of products, including air-operated double diaphragm pumps, air motors, ventilation fans, and surface preparation equipment. Teryair also offers a variety of services, including customization, repair, and maintenance.

Why Choose Teryair ?

Here are some of the reasons why you should choose Teryair :

1

Durability and reliability: Our products are designed to withstand the harsh conditions of the a marine environment. They are made from high-quality materials and are built to last.

2

Easy to maintain: Our products are easy to maintain and come with detailed instructions. We offer a comprehensive range of spare parts, so you can keep your equipment running smoothly.

3

Worldwide spares availability: We have a network of authorized distributors around the world, so you can always get the spare parts you need, when you need them.

4

Top industry certifications: Our products are certified to the highest international standards, such as ATEX, CE, ISO, and Lloyd's Register. This ensures that our products meet the highest standards of safety and quality.

5

Ever-growing product portfolio: We are constantly expanding our product portfolio to meet the needs of our customers. This means that you can always find the right product for your application.

If you are looking for High-quality pneumatic machinery for your marine vessel, Teryair is the company to trust. We are committed to providing our customers with excellent service.

Contact us today to learn more about our products and service

Certifications & Memberships





Technical Ship
Supply Products

Air Operated Diaphragm
Pumps



Air Motors

Surface Preparation
Equipment



High-Pressure
Water Jet Series

Industrial
Ventilation Fans



Airless Paint Sprayers



CONTENTS

IMPA 59

Pneumatic Impact Wrenches	Page 06
Pneumatic Grinders - Angle Grinder / Scalers	Page 06
Pneumatic Hand Drills	Page 07
Pneumatic Chipping Hammers	Page 07
Pneumatic Tungsten Tipped Scabblers	Page 08
Pneumatic Hard Steel Tipped Scabblers	Page 09
Pneumatic "Walk Behind" Deck Scabblers	Page 10
Rotary Deck Scalers - Pneumatic and Electric	Page 11 / 12
Pneumatic Lightweight Needle Scalers and Spares	Page 13 to 17
Pneumatic Heavy Duty Needle Scalers	Page 18
Pneumatic Low Vibration Needle Scalers	Page 19
Spare Needles For Needle Scalers	Page 20
Pneumatic Heavy Duty Chisel Scalers	Page 21
Pneumatic Low vibration Chisel Scalers	Page 22
Chisels For Use With Heavy Duty and Low Vibration	Page 23
Pneumatic Long Reach Scalers	Page 24 / 25
Pneumatic Mucking Winches	Page 26
Pneumatic Vacuum Cleaner	Page 27
Tank Cleaning Machines	Page 28 / 29
Pneumatic Hold Cleaning Guns	Page 30
Pneumatic High Pressure Cleaner	Page 31
Electric High Pressure Cleaners	Page 32
Air Motors	Page 33
Portable Electric Drills	Page 34
Electric Angle Grinders	Page 34
Electric Needle Scalers	Page 35
Rotary Scaling Machines	Page 36 / 37
Portable Ventilation Fans	Page 38 / 39
Ventilation Tubes	Page 40
Water Turbine Fans	Page 41
Air Driven Fans	Page 42
Pneumatic Diaphragm Pumps	Page 43 to 46
Pneumatic Sump Pumps	Page 47 / 48
Pneumatic Drum Pump	Page 49

IMPA 27

Airless Paint Sprayers	Page 50
Airless Paint Spray Hand Guns	Page 51
Airless Paint Spray Pole Guns	Page 51
High Pressure Nylon Hose	Page 52
Paint Stirrers	Page 52
High-Pressure Airless Spray Tips	Page 53

IMPA 35

Rubber Air Hose	Page 54
Water Rubber Hose	Page 54
Cast Bronze Air Hose Couplings	Page 55
Quick Connect Couplers	Page 55 to 57
Double End Shut Off Couplers	Page 57
Line Couplers	Page 58

IMPA 61

Punching Tool Set	Page 58
Grease Lubricators Air Operated	Page 59
Spur-Gear Chain Hoist	Page 59
Non-Spark Chain Hoist	Page 60
Valve Seat Cutters	Page 60

IMPA 33

Compressed Air Safety Lights	Page 61
------------------------------	---------

IMPA 23

Scupper Plugs	Page 62
---------------	---------

Features

Compact ergonomic design for increased comfort. Ideal for general assembly and disassembly. Teryair impact wrenches use the rocking dog mechanism that provides powerful torque with durable components. Aluminum die cast housings and heat treated impact component are used throughout.

Applications

Rapid assembly and disassembly of fasteners in various industries, for improved productivity.

Standard equipment included

- Allen Key.
- Quick connect coupler 20 pm.



PIW19



PIW25

Technical data

IMPA Code	Teryair Model No	Square Drive		Nom Bolt dia mm	Free Speed rpm	Air Inlet PT	Air Hose Size mm	Net Weight kgs
		mm	inch					
590101	PIW-13	12.7	1/2	13	6,500	1/4	6.0	2.0
590105	PIW-19	19.0	3/4	22	4,000	1/4	6.0	4.5
590106	PIW-25	25.4	1	32	3500	1/2	12.7	8.0

Package dimensions & weight

Teryair Model No	Weight kgs	Box Dimensions cms
PIW-13	2.5	22 x 20 x 8
PIW-19	5.0	28 x 28 x 12
PIW-25	9.0	60 x 40 x 24

Lightweight aluminum die cast bodies, strong and durable. These grinders can be used with a variety of accessories. They feature hardened motor parts and silent spiral bevel gearing* (*on angled tools).

Features

- Lightweight for easy manoeuvring.
- Variety of accessories offers multipurpose usage.

Applications

For sanding, rough grinding and removal of rust / paint from metal surfaces.

Standard equipment included

- Quick connect coupler 20 PM.
- Allen key.
- Spanner.
- Safety guard for AG4 / AG7.



AG4



AG7



LG25K

Technical data

IMPA Code	Teryair Model No	Wheel Size O.D. x T x I.D. mm	Free Speed rpm	Air Inlet PT	Air Hose mm	Weight kgs
590301	AG4	100 x 6 x 15	13,000	3/8	9.00	1.3
590302	AG7	180 x 6 x 22	7,600	3/8	13.00	3.2
590326	LG25K	6mm Collet Chuck	25,000	1/4	9.50	0.6

Package dimensions & weight

Teryair Model No	Weight kgs	Box Dimensions cms
AG4	1.5	13 x 12 x 24
AG7	3.5	36 x 24 x 7
LG25K	0.8	19 x 7.5 x 5

Pneumatic Hand Drills - 6.5mm, 8mm, 9.5mm and 13mm

Teryair pneumatic drills have a high power to weight ratio and are comfortable to handle for long working hours. Four models covering up to 13mm in steel. Drill chucks are supplied as standard equipment. Minimum vibration during drilling operations, quiet operation thanks to precision gearing.

Features

- Low vibration.
- High power to weight ratio.
- Reversible.

Standard equipment included

- Quick connect coupler 20 PM.
- Steady handle (PD13PG only).
- Drill Chucks and key.



PD6PG



PD13PG

Applications

For light and medium duty drilling.

Technical data

IMPA Code	Teryair Model No	Drilling Capacity mm	Collect Chuck Size mm	Free Speed rpm	Air Inlet PT	Air Hose mm	Net Weight kgs
590341	PD6PG	6.5	6.5	2900	1/4	9.5	1.1
590342	PD10PG	9.5	10.0	1400	1/4	9.5	1.1
590346	PD8PG	8.0	8.0	1500	1/4	9.5	1.1
590347	PD13PG	13.0	13.0	700	3/4	9.5	1.7

Package dimensions & weight

Teryair Model No	Weight kgs	Box Dimensions cms
PD6PG	1.5	22 x 20 x 8
PD10PG	1.5	22 x 20 x 8
PD8PG	1.5	22 x 20 x 8
PD13PG	2.0	22 x 20 x 8

Pneumatic Chipping Hammers - 10mm Round Chuck

These pneumatic chipping hammers are the perfect tool for any light duty chipping work such as the removal of unwanted material like concrete, tiles, rust, dirt from the base material surface. A variety of chisels are available for different applications Chisels as shown are part of standard equipment.

Features

- Hard hitting and high frequency of blows
- Accepts universally available 10mm shank accessories

Applications

For removal of paint, rust, calking/weld flux, for billet chipping and general chipping

Standard equipment included

- Moil point tool.
- Chisel point tool 3 nos.
- Quick connect coupler 20 PM.



CH26R



CH23R

Technical data

IMPA Code	Teryair Model No	Type of Shank	Blows per minute	Piston Dia mm	Air Inlet PT	Air Hose mm	Weight kgs
590361	CH26R	Round	2600	19.0	3/8	9.5	1.5
590362	CH23H	Round	2300	18.0	1/4	9.5	2.0

Package dimensions & weight

Teryair Model No	Weight kgs	Box Dimensions cms
CH26R	1.7	22 x 20 x 8
CH23H	2.1	22 x 20 x 8

These handheld tools are the best when it comes to the removal of scaly rust or heavy coatings. They are hard hitting and have replaceable tungsten tipped pistons. They find application in the Oil and Gas, Marine and Construction industries.



1SC

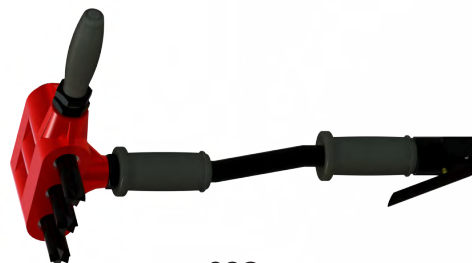

3SC

Features

- Lever type throttle, control and ease of use.
- Simple piston mechanism, easy to maintain.
- Light weight, less operator fatigue and easy to manoeuvre.
- Suitable for use on small hard-to-reach areas as well as for maintenance work on larger areas.

Applications

- Removal of heavy rust or chemical coatings.
- Removal of fresh concrete layers.
- To roughen the substrate creating the correct profile to bond construction materials such as concrete and grouts
- Removal of grout, mortar, laitance, encrustations, paint, wood, and rust.
- Scabbling concrete to expose aggregate

Technical data

IMPA Code	590381A	590383
Teryair Model No	1SC	3SC
Number of Pistons	1	3
Piston Dia mm	22.0	22.0
Air Inlet PT	3/8	3/8
Air Hose Size	9.5	12.7
Net Weight kgs	2.7	5.6

Additional data

Teryair Model No	1SC	3SC
Piston Length mm	111	111
Piston Stroke mm	26.2	26.2
Maximum operating pressure kg/cm ² (psi)	6 (90)	6 (90)
Air Consumption (No Load) cfm (m ³ /min)	8 (0.23)	15 (0.42)

Optional equipment

1212121 piston with copper beryllium tips .

Package dimensions and weights

Teryair Model No	Weight kgs	Box Dimensions cms
1SC	3.5	52 x 14 x 6
3SC	7.0	49 x 17 x 17

Dimension drawing

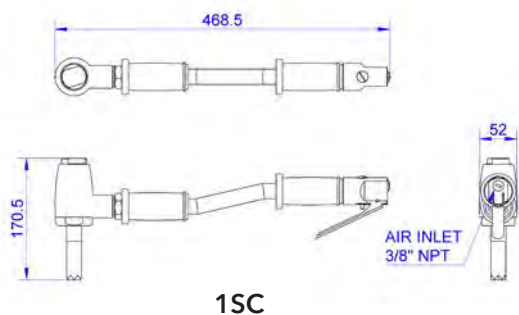

1SC

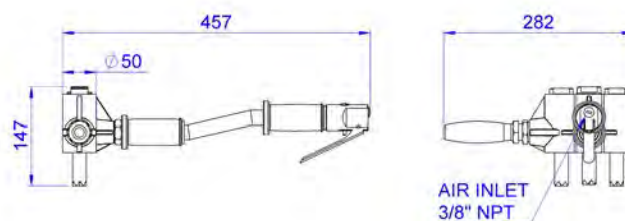

3SC

Practical and economical, the teryair X2 has been the workhorse of the industry. It's easy to maintain and lightweight to use. The twist throttle mechanism is comfortable and fatigue free for operators.

Features

- Twist type throttle, control and ease of use
- Hardened alloy steel Pistons, economical
- Simple piston mechanism, easy to maintain
- Light weight, less operator fatigue and easy to manoeuvre.

Applications

- Removal of heavy and stubborn layers of rust
- Removal of hard chemical coatings.



Technical data

IMPA Code	590382
Teryair Model No	X2
Number of Pistons	1
Piston Dia mm	30
Air Inlet PT	9.5
Net Weight kgs	2.6

Additional data

Teryair Model No	X2
Piston Length mm	72
Piston Stroke mm	21.3
Maximum operating pressure kg/cm ² (psi)	6
Air Consumption cfm (m ³ /min)	7 (0.20)

Package dimensions and weights

Teryair Model No	Weight kgs	Box Dimensions cms
X2	3.5	52 x 14 x 6

Dimension drawing

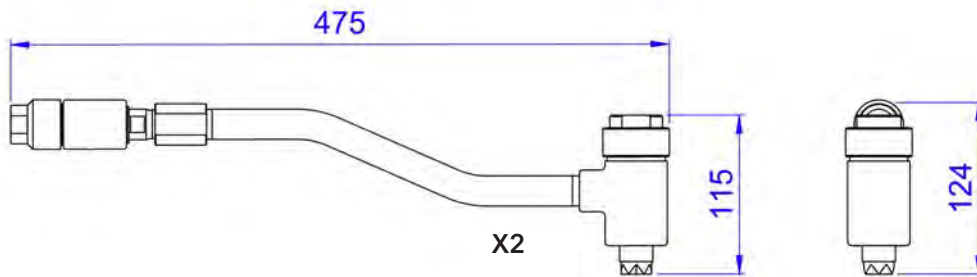

Pneumatic "Walk Behind" Deck Scabblers - Light, Medium and Heavy Duty Variants

When it comes to large surface area descaling nothing, does the job like a Teryair Deck Scabbler. Three models to choose from depending on the severity of the job. All three models feature easy to use ergonomics for long work hours and easy and quick replacement of wearing parts.

Eleven individually firing pistons make it easy for the descaling action to follow the surface contours. Ideal for pre blast preparation. FPLD-11 and FPHD-11 feature tungsten tipped pistons for heavy duty applications, PDS-11 has hardened steel pistons for regular duty applications

Features

- Eleven independently hitting pistons cover irregular surfaces.
- Quick change consumables.
- Ergonomically designed for minimum operator fatigue.

Applications

- Marine, removal of old rust, paint, or coatings from decks, platforms, floors and surfaces.
- Construction industry, preparation of concrete surfaces to Create effective bonds.

Technical data

IMPA code	590401	590405	-
Teryair Model No	PDS-11	FPLD-11	FPHD-11
Scaling System	Reciprocating Piston System		
Number of Piston Heads pcs	11		
Piston Diameter mm	22	27	29
Blows per min	4000	3000	2200
Scaling Width mm	300	252	250
Weight kgs	45.0	36.0	70.0



PDS 11

FPLD 11

FPHD 11

Accessories & spares

1289700 Repair kit for PDS11
1269700 Repair kit for FPLD11
1309700 Repair kit for FPHD11

Optional equipment

PDS-11	1282102 Piston - 11 pcs
FPLD-11	1262104 Piston - 11 pcs
FPHD-11	1302135 Piston - 11 pcs

Package dimensions and weights

Teryair Model No	Weight kgs	Box Dimensions cms
PDS-11	50.0	99 x 47 x 32
FPLD-11	45.0	125 x 61 x 66
FPHD-11	80.0	125 x 61 x 66

Dimension drawing

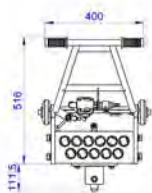

PDS 11



FPLD 11

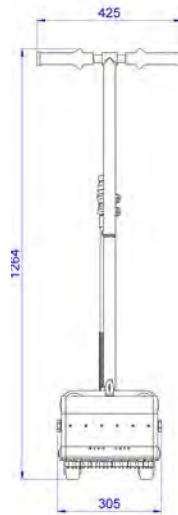

FPHD 11



Good for large area deck descaling, these machines have easy to change rotary drums. Depending on the thickness of the coating layer or corrosion layer one can select a suitable drum type. The cut height is further adjustable by a handwheel during operation. The machines are designed such that the drums can be quickly interchanged on the job with minimum time and tools. Various pneumatic and electric motor options are available.

Features

- Easy to change drums.
- Drum options, cutter drum for heavy chipping action, leaf drum for light chipping action and wire brush drum for final finishing action.
- Drum to ground engagement height is easily adjustable dynamically with a handwheel.
- Electric or pneumatic versions available.

Applications

- Marine, removal of old rust, paint, or coatings from decks, platforms, floors and surfaces.
- Construction industry, preparation of concrete surfaces to create effective bonds with subsequent layering. Edge removal and smoothing.



PRDS 84

ERDS 84

Technical data

IMPA code	590406	590409	590409A	590409B	590409C
Teryair Model No	PRDS-84	ERDS84-220V3	ERDS84-440V	ERDS84-110V	ERDS84-220V
Scaling System	Rotary scaling system				
Number of Scaling Heads	63 pcs of striking blades or 60 pcs of cutter gear				
Motor	6VMLALEXR	AC 220V 3 Ph	AC 440V 3 Ph	AC 110V 1 Ph	AC 220V 1Ph
rpm	3000		3470		
Scaling Width mm	280		280		
Weight kgs	75.0	75.0	75.0	75.0	75.0



Package dimensions and weights



Teryair Model No	Weight kgs	Box Dimensions cms
PRDS84	80.0	125 x 61 x 66
ERDS84 Series	80.0	125 x 61 x 66

Standard equipment included assembled

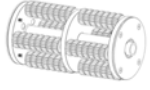
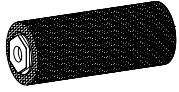
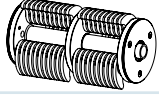
6539701 - Cutter blade assembly.

Accessories & spares

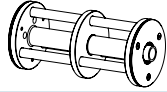
	6539702 - Cutter gear assembly
	59.04.18 - Wire wheel brush
	6539701 Cutter blade assembly
	59.12.56 - Cutter

	340.347 - Leafs
	6539711 - Bare drum with lock plates
	Washer
	Pin

Dimension drawing

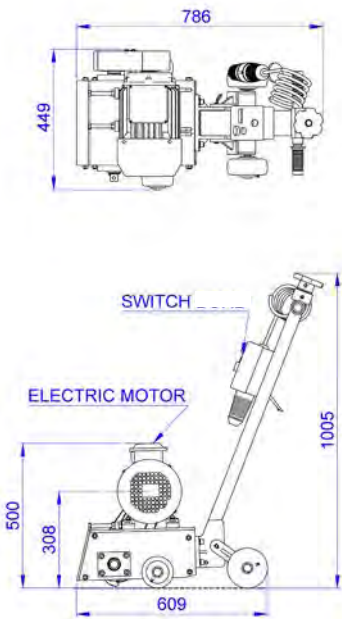

ERDS 84

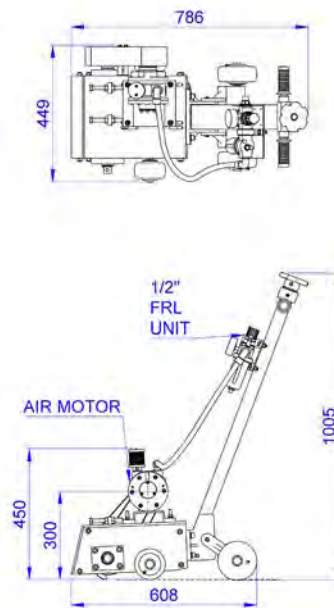
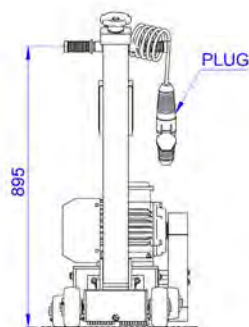

PRDS 84

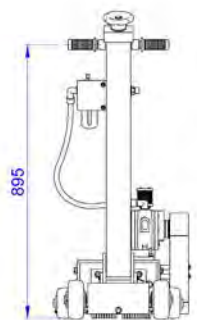

These models are all designed to be lightweight with the focus on operator comfort. The popular 4 sizes are found onboard on almost every sea going vessel. Ideal for routine tasks or descaling in hard to reach areas. Needles are easily replaceable. 2mm, 3mm and 4mm needles and fast wearing parts and complete assemblies are readily available globally in any port and are

competitively priced keeping a check on your maintenance costs. Yellow H suffixed models are economy priced models. Needle supporters, Pistons, needles and other spares are interchangeable with generic models



N 24



HN 24



N 28



HN 28



SN16PG



SN20ST

Features

- High degree of parts interchangeability between models
- Quick change needles
- Lightweight housings
- Independent needle motion ensures descaling coverage over irregular surfaces like bolt heads, corners and other hard to access areas.

Applications

- Marine, off-shore and petrochemical hold cleaning, general deck and surface cleaning. Removal of heavy rust on tankers and dry dock applications. Tank descaling. Descaling of structures prior to painting
- Paint removal, and other industrial coating removal from floors and other surfaces.
- Construction - removal of concrete residue from rebar, cleaning of cement from plant and vehicles. Weld cleaning.

Technical data

IMPA Code	Teryair Model No	O.A. Length mm	Needles mm	Air Inlet	Air Consumption m ³ /min	Weight kgs
590461	SN16PG	159	2 mm x 29 pcs	M16 x 1.5P	0.15	1.4
590462	SN20ST	245	2 mm x 29 pcs 3 mm x 12 pcs	M16 x 1.5P	0.20	2.4
590463	N24 / HN24	237	2 mm x 53 pcs 3 mm x 23 pcs	M 16 x 1.5P	0.27	2.7
590464	N28 / HN28	264	2 mm x 66 pcs 3 mm x 28 pcs 4 mm x 14 pcs	M16 x 1.5P	0.35	3.5

Additional data

Teryair Model No	Maximum Operating Pressure	Blows Per minute
SN16PG		4000
SN20ST		4000
N24 / HN24	6kg/cm ² (90 psi)	4000
N28 / HN28		4500

Note: N24 and N28 are aluminum polished finished, HN24 and HH28 are painted finishes. Technical performance of polished and yellow painted finish are the same.

Dimension drawing

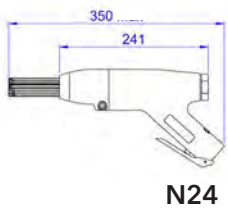

N24

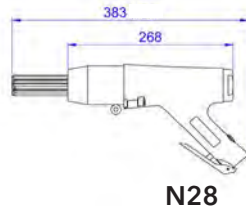

N28

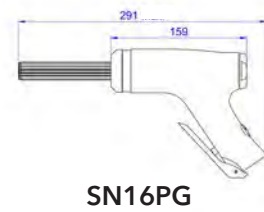

SN16PG

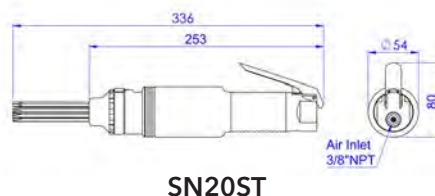

SN20ST

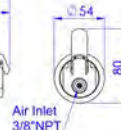















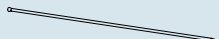



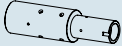



Standard equipment included

N24/HN24	0224052 Hose Nipple
N28/HN28	
SN16PG	
SN20ST	

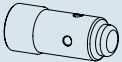
Accessories and spares

Note: for needle replacement information, please go to page 13











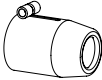



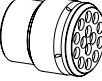
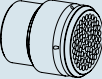

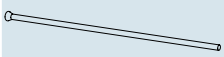

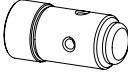

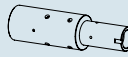
For N24 Needle scaler

Teryair Model No	Image	Part description	Qty/ tool
0224001		Needle guide	1
0224017		Stop ring	1
0229063		Hex nut	1
0229061		Clamp bolt	1
0229004OL		Needle 3mm x 180mm	23
0229008		Needle 2mm x 180mm	53
0224045		Needle Supporter 3mm	1
0224047		Needle Supporter 2mm	1
0224019		Throttle anvil	1
0224002		Cylinder	1
0229023		Cylinder lock pin	1
0224005		Front washer	1
0224003		O ring Housing	1
0224007		Housing	1
0229029A		Throttle valve assembly	1
0229027		Valve packing	1
0229025		Valve cap	1
0224009		Piston	1
0224011		Rear washer	1
0224013		Rear plug	1
0229031		Throttle lever	1
0229033		Lever pin	1
0229043		Hose nipple	1
0229041		Reducer	1

Accessories and spares

Note: for needle replacement information, please go to page 13













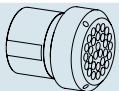

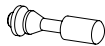
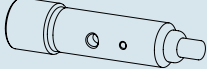
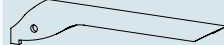
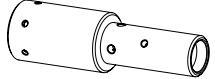

For N28 / HN28 Needle scaler

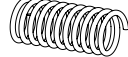
Teryair Model No	Image	Part description	Qty/ tool
0229035		Needle guide	1
0229062		Clamp bolt	1
0229001		Stop ring	1
0229003		Needle Supporter 3mm	1
0229005		Needle Supporter 4mm	1
0229007		Needle Supporter 2mm	1
0229004OL		Needle 3mm x 180mm	28
0229006		Needle 4mm x 180mm	14
0229008		Needle 2mm x 180mm	65
0229009		Throttle anvil	1
0229011		Piston	1
0229012		O ring Cylinder	2
0229013		Safety band	1
0229014		Cylinder	1
0229023		Cylinder lock pin	1
0229017		Front washer	1
0229045		Housing	1
0229021		Rear washer	1
0229029A		Throttle valve assembly	1
0229027		Valve packing	1
0229025		Valve cap	1
0229047		Rear bolt	1
0229031		Throttle lever	1
0229033		Lever	1

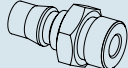
Accessories and spares

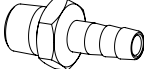
Note: for needle replacement information, please go to page 13











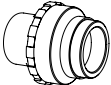
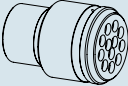



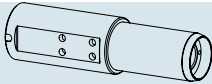
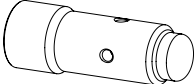

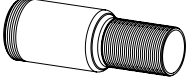
For SN16PG Needle Scaler

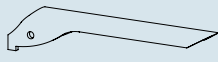
Teryair Model No	Image	Part description	Qty/ tool				
				1352107		Rear bolt	1
1355111OL		Needle 2mm x 150mm	29	0229025		Valve cap	1
1352106		Needle Supporter 2mm	1	0229027		Valve packing	1
1352102		Throttle anvil	1	0229029		Throttle valve	1
1352103		Piston	1	0229031		Throttle lever	1
1352104		Cylinder	1	0229033		Lever pin	1
1352105		Stop ring	1	0229030		O ring for throttle valve	1
1354008		O ring	1	0229040		Spring for throttle valve	1
1405112		Safety band	1	0224052		Hose nipple	
1351001		Housing	1	0229043		Hose nipple	1
1354009		O ring for cylinder	1	0229041		Reducer	1
1354010		Rear washer	1	0229031		Throttle lever	1

Accessories and spares

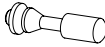
Note: for needle replacement information, please go to page 13

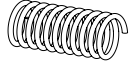
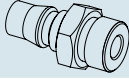
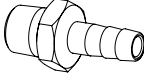
For SN20ST Needle Scaler

Teryair Model No	Image	Part description	Qty/ tool
1402101		Stop ring	1
1402102		Needle supporter 3mm	1
0229004OL		Needle 3mm x 180mm	12
1402103		Throttle anvil	1
1405112		Safety band	1
1402104		Cylinder	1
1402105		Piston	1
1404008		Front washer	1
1404009		Cover for cylinder	1
1404010		O ring for control body	1
1402106		Control body	1
0229031		Throttle lever	1
1005019		Lever pin	1
1402107		Valve cap	1
1404011		O ring for valve cap	1
1409013		Internal circlip	1
0229029		Throttle valve	1
0229030		O ring for throttle valve	1
0229040		Spring for throttle valve	1
0224052		Hose nipple	
0229043		Hose nipple	1
0229041		Reducer	1

These steel-bodied tools are durable machines. Also available in straight and pistol grip versions to suit every operator's preference. A high degree of parts interchangeability within sizes makes for convenient inventory management. Choose from different types of chisel types or needle sizes to achieve desired results.

Features

- Hardened steel cylinder - durable
- Pistol grip handle.
- Choice of needle sizes
- High power to weight ratio.
- Lightweight - easy to use and manoeuvre.
- Simple to maintain - few moving parts.
- Quick change needles
- Capable of descaling irregular surfaces, crevices etc

Applications

- Cleaning of weld splatter and flux
- Descaling
- Reaching hard to reach areas
- Paint removal
- Corrosion removal, prior to re-coating or painting
- General surface preparation

These tools are great for use in general industry, shipyards, maintenance of sea going vessels, offshore platforms etc.

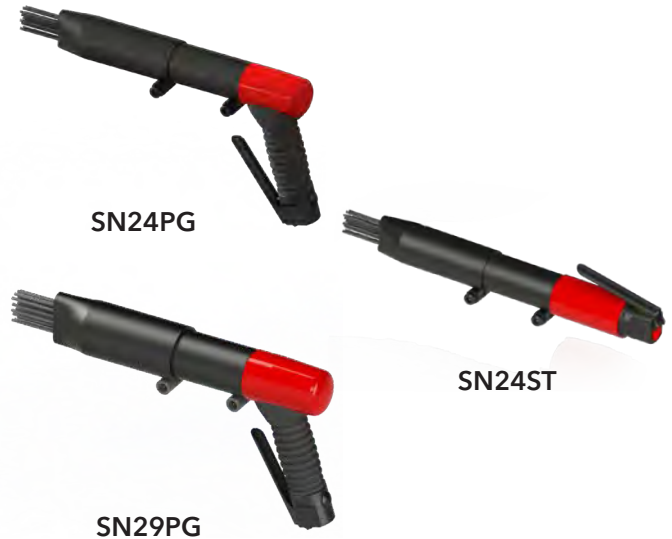

Technical data

IMPA Code	590481	590482	590483
Teryair Model No	SN24ST	SN24PG	SN29PG
Type	Inline	Pistol Grip	
Blows per min	3000	3000	2200
Air Consumption ltrs/sec (cfm)	2.6 (5.5)	2.6 (5.5)	3.8 (8)
Air Inlet Size inch	NPT 1/4		
Length mm (inch)	375 (14.7)	315 (12.4)	342 (13.5)
Weight kgs (lbs)	2.6 (5.8)	2.6 (5.7)	3.7 (8.2)
Needles	51 x 2 mm 19 x 3 mm	51 x 2 mm 19 x 3 mm	65 x 2 mm 28 x 3 mm

Package dimensions and weights

Teryair Model No	Weight kgs	Box Dimensions cms
SN24ST	3.0	7 x 7 x 41
SN24PG	3.0	35 x 19 x 7
SN29PG	4.5	21 x 74 x 41

Accessories and spares

See page 20 for available needles

Standard equipment included

SN24ST	SN24PG	SN29PG
0229004BL 3mm x 180 mm Long needles - 19 pcs	0229004BL 3mm x 180 mm Long needles - 19 pcs	0229004BL 3mm x 180 mm Long needles - 28 pcs

Dimension drawing

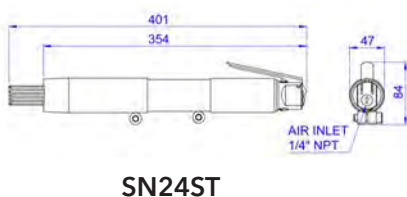

SN24ST

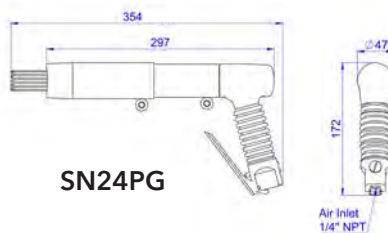

SN24PG

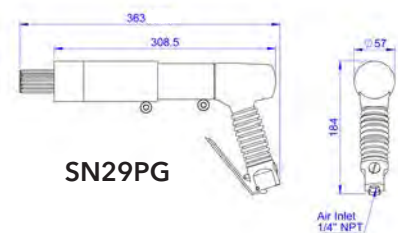

SN29PG

Vibration reduced tools transfer negligible vibration and offer greater comfort to the operator. Ideal for removal of unwanted layers, these scalers are able to use different needle sizes for ideal results.

Features

- Low vibration - easy on operators.
- Hardened steel cylinder - durable.
- Pistol grip handle.
- Choice of needle sizes
- High power to weight ratio.
- Lightweight - easy to use and manoeuvre.
- Simple to maintain - few moving parts.

Applications

- Cleaning of weld splatter and flux
- Descaling
- Reaching hard to reach areas
- Paint removal
- Corrosion removal, prior to re-coating or painting
- General surface preparation

These tools are great for use in general industry, shipyards, maintenance of sea going vessels, offshore platforms etc.



Technical data

IMPA Code	590518	590500	590510
Teryair Model No	SN39STVL	SN39PGVL	SN45PGVL
Type	Inline	Pistol Grip	
Blows per min	2400	2400	3000
Air Consumption ltrs/sec (cfm)	1.89 (4)	1.89 (4)	4.0 (8.5)
Noise Level LwA dB(A)	90.7	90.7	109.50
Vibration (AEQ) m/s ²	2.56	2.56	2.3
Air Inlet Size inch	NPT 1/4		
Length mm (inch)	370 (14.5)	340 (13.4)	370 (14.5)
Weight kgs (lbs)	2.95 (6.5)	2.7 (6.0)	3.5 (7.7)
Needles	19 x 3mm	19 x 3mm	65 x 2mm 28 x 3mm 19 x 4mm

Package dimensions and weights

Teryair Model No	Weight kgs	Box Dimensions cms
SN39STVL	3.5	7 x 7 x 41
SN39PGVL	3.5	35 x 19 x 7
SN45PGVL	4.5	21 x 7 x 41

Accessories and spares

See page 20 for available needles

Standard equipment included

SN39STVL	SN39PGVL	SN45PGVL
0229004BL 3mm x 180 mm Long needles - 19 pcs	0229004BL 3mm x 180 mm Long needles - 19 pcs	0229004BL 3mm x 180 mm Long needles - 28 pcs

Dimension drawing

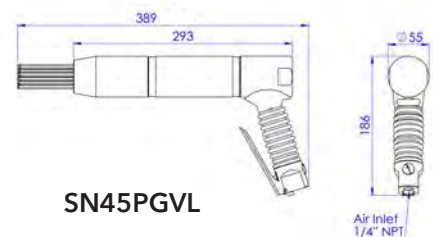
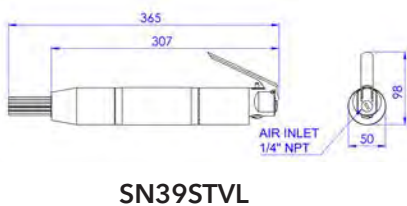

Spare Needles For Needle Scalers (Suits All Brands Of Needle Scalers/Jet Chisels)

Teryair extra long life needles are made from premium alloy steel with molybdenum nickel and manganese added. These elements give these needles extra hard wear resistance over standard needles.

Choose from 2, 3 or 4mm sizes.

Special lengths and tips are made to order.









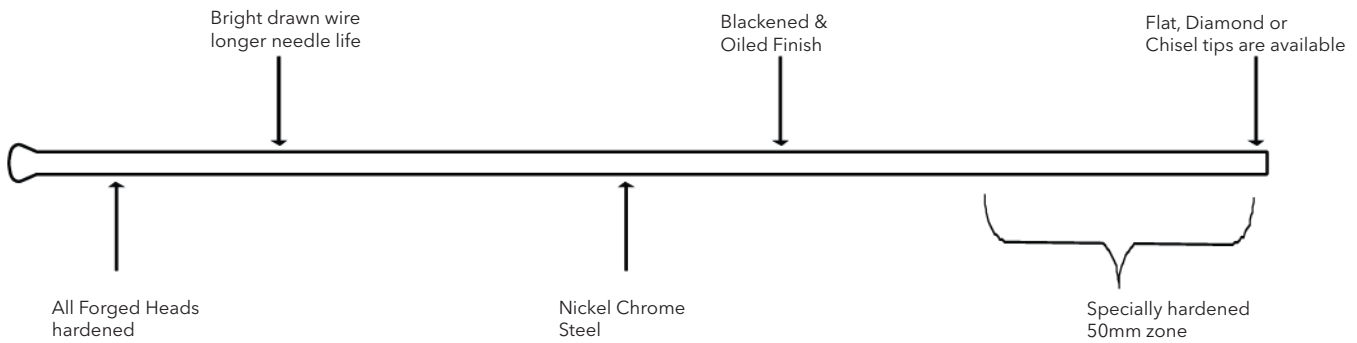



Nickel Chrome Steel



Copper Beryllium



Nickel Chrome Steel

IMPA Code	Teryair Part No	Size	Shape of Tip	Per Set pcs
590466	NR2150FO	2 mm x 150 mm	Flat Tip 	100
590467	NR2180FO	2 mm x 180 mm	Flat Tip 	100
590468	NR3180FO	3 mm x 180 mm	Flat Tip 	100
	NR3180CO	3 mm x 180 mm	Chisel Tip 	100
	NR3180DO	3 mm x 180 mm	Diamond Tip 	100
590469	NR4180FO	4 mm x 180 mm	Flat Tip 	50
590486	0229008OL	2 mm x 180 mm	Flat Tip 	1
590487 590488 590489	0229004HTCP 1005121DMOL 0229004OL	3 mm x 180 mm	Flat Tip  Chisel Tip  Pointed Tip 	1 1 1
590492	0229006OL	4 mm x 180 mm	Flat Tip 	1

Copper Beryllium - Non Spark

IMPA Code	Teryair Part No	Size	Shape of Tip	Per Set
-	2L3180FCB	3 mm x 180 mm	Flat Tip 	100

These are hard hitting scalers with the options of quick chisel changes. Select from a variety of chisels to remove unwanted accumulated layers.

Features

- Hardened steel cylinder - durable.
- Pistol grip handle.
- Variety of chisels available.
- High power to weight ratio.
- Lightweight - easy to use and manoeuvre.
- Simple to maintain - few moving parts.
- Quick change retainer system - chisels and accessories can be changed quickly.

Applications

- Cleaning of weld splatter and flux.
- Descaling.
- Reaching hard to reach areas.
- Paint removal.
- Corrosion removal, prior to re-coating or painting.
- General surface preparation.

These tools are great for use in general industry, shipyards, maintenance of sea going vessels, offshore platforms etc.



Technical data

IMPA Code	590581	590582	590583
Teryair Model No	SC24ST	SC24PG	SC29PG
Type	Inline	Pistol Grip	
Blows per min	3000	3000	2200
Air Consumption ltrs/sec (cfm)	2.6 (5.5)	2.6 (5.5)	3.8 (8)
Air Inlet Size inch	NPT 1/4		
Length mm (inch)	370 (14.5)	340 (13.4)	370 (14.5)
Weight kgs (lbs)	2.0 (4.4)	2.0 (4.4)	2.6 (5.8)
Standard Accessories	Chisel 1/2" sq, 7" Long, 3/4" Wide, JC0175F19 - 1pc		

Package dimensions and weights

Teryair Model No	Weight kgs	Box Dimensions cms
SC24ST	2.5	7 x 7 x 41
SC24PG	3.5	35 x 19 x 7
SC29PG	4.0	35 x 19 x 7

Accessories and spares

See page 23 for jc series chisel list

Standard equipment included

Chisel 1/2" sq, 7" Long, 3/4" Wide, JC0175F19 - 1pc

Dimension drawing

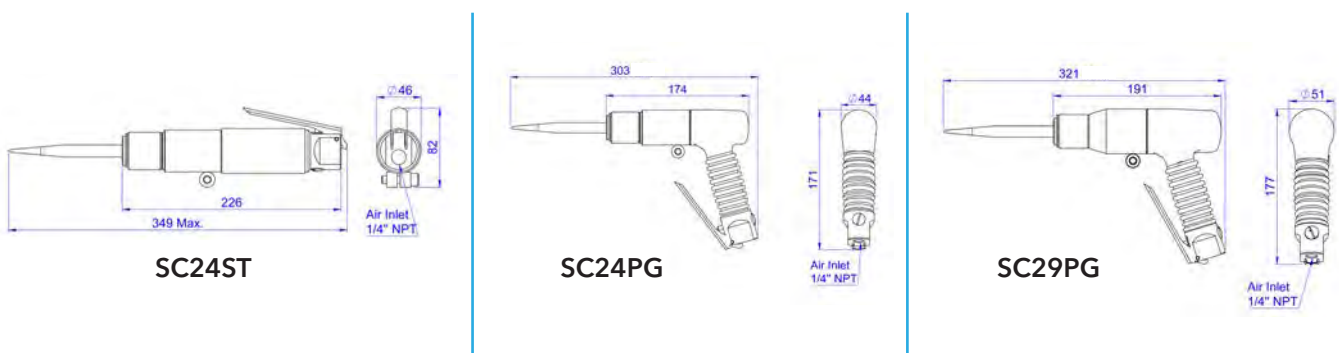

Vibration reduced tools transfer negligible vibration and offer greater comfort to the operator. A variety of chisels can be easily interchanged to achieve desired results of removal of unwanted buildup of layers

Features

- Low vibration - easy on operators.
- Hardened steel cylinder - durable.
- pistol grip handle.
- Variety of chisels available.
- High power to weight ratio.
- Lightweight - easy to use and manoeuvre.
- Simple to maintain - few moving parts.
- Quick change retainer system - chisels and accessories can be changed quickly.

Applications

- Cleaning of weld splatter and flux.
- Descaling.
- Reaching hard to reach areas.
- Paint removal.
- Corrosion removal, prior to re-coating or painting.
- General surface preparation.



These tools are great for use in general industry, shipyards, maintenance of sea going vessels, offshore platforms etc.

Technical data

IMPA Code	590519	590513	590514
Teryair Model No	SC39STVL	SC39PGVL	SC45PGVL
Type	In Line	Pistol Grip	
Blows per min	2400	2400	3000
Air Consumption ltrs/sec (cfm)	1.89 (4)	1.89 (4)	2.6 (5.5)
Noise Level LwA dB(A)	76.3	76.3	78.2
Vibration (AEQ) m/s ²	3.69	3.33	3.7
Air Inlet Size inch	NPT 1/4		
Length mm (inch)	370 (14.5)	340 (13.4)	370 (14.5)
Weight kgs (lbs)	2.95 (6.5)	3.20 (7.05)	4.0 (8.8)
Standard Accessories	Chisel 1/2" sq, 7" Long, 3/4" Wide, JD0175F19 - 1pc		

Package dimensions and weights

Teryair Model No	Weight kgs	Box Dimensions cms
SC39STVL	3.0	7 x 7 x 41
SC39PGVL	3.0	35 x 19 x 7
SC45PGVL	6.0	21 x 74 x 41

Accessories and spares

See page 23 for jd series chisel list



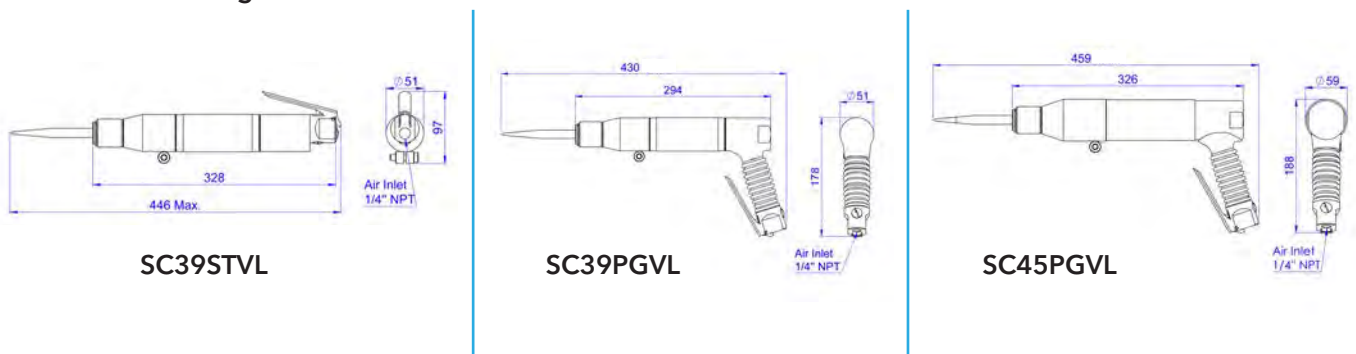

Standard equipment included

Chisel 1/2" sq, 7" Long, 3/4" Wide, JD0175F19 - 1pc

Dimension drawing



Chisels for use with chisel scalers.
Suits most brands of chisel scalers.

Images	IMPA Code	Blade Size mm		Type	Teryair Part No
		Width mm (inch)	Length mm (inch)		
	590591	19 (3/4)	175 (7)		JC0175F19
	590592	19 (3/4)	254 (10)	Flat	JC0250F19
	590593	62 (2-1/2)	175 (7)		JC0175F65
	590594	62 (2-1/2)	254 (10)		JC0250F65
	590595	34 (1-3/8)	175 (7)	Cranked	JC0175C35
	591901	19 (3/4)	175 (7)		JD0175F19
	591902	62 (2-1/2)	175 (7)	Flat	JD0175F65
	591903	50 (2)	175 (7)		JD0175F50
	591904	34 (1-3/8")	175 (7)	Cranked	JD0175C35
	591905	19 (3/4)	254 (10")		JD0250F19
				Flat	

Teryair Long Reach Scalers are available in different long lengths to access hard to reach areas. Excellent for removal of corrosion and layers from floors and surfaces. A variety of accessories of chisels and blades are available depending on the type of layer that needs removing. All accessories are quick change

Features

- Hardened steel cylinder - durable.
- Pistol grip handle.
- Choice of needle sizes.
- High power to weight ratio.
- Lightweight - easy to use and manoeuvre.
- Simple to maintain - few moving parts.
- Quick change retainer system
Chisels and accessories can be changed quickly.

Applications

- Great for removal of salt water corrosion and marine growth on cargo ships decks.
- Chipping and scaling in hard to reach areas.
- Great for removal of tiles/ carpet from floors.
- Removal of stubborn adhesives from floors.



LR Series

Technical data

IMPA Code	590451	590452	590453	590454
Teryair Model No	LR076	LR116	LR146	LR176
BPM	2200			
Air Consumption ltrs/sec (cfm)	2.1 (4.5)			
Length mm	760	1160	1460 mm	1760
Weight kgs (lbs)	4.6 (8.2)	5.2 (11.51)	5.8 (12.9)	6.3 (13.9)

Standard equipment included

IMPA Code	LR076	LR116	LR146	LR176
Teryair Model No	JB0222FC4, 5/8" Hex Chisel , 8" Long			

Accessories and spares

See list on page 25

Package dimensions and weights

Teryair Model No	Weight kgs	Box Dimensions cms
LR076	6.5	79 x 10 x 8
LR116	7.0	121 x 10 x 8
LR146	7.5	144 x 10 x 8
LR176	9.0	173 x 10 x 9

Models	Length (L) mm
LR076	760
LR116	1160
LR146	1460
LR176	1760

Dimension drawing

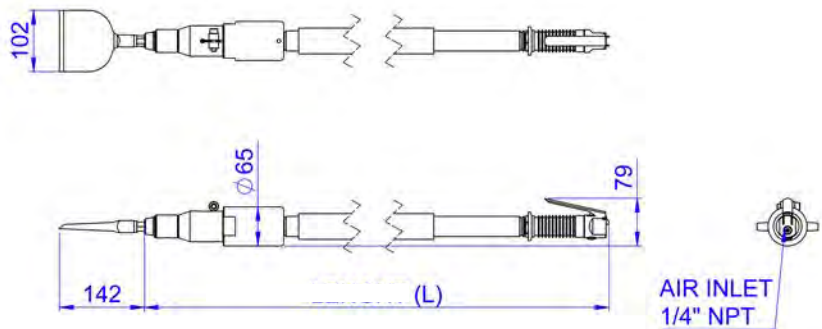

Accessories for Long Reach Scalers

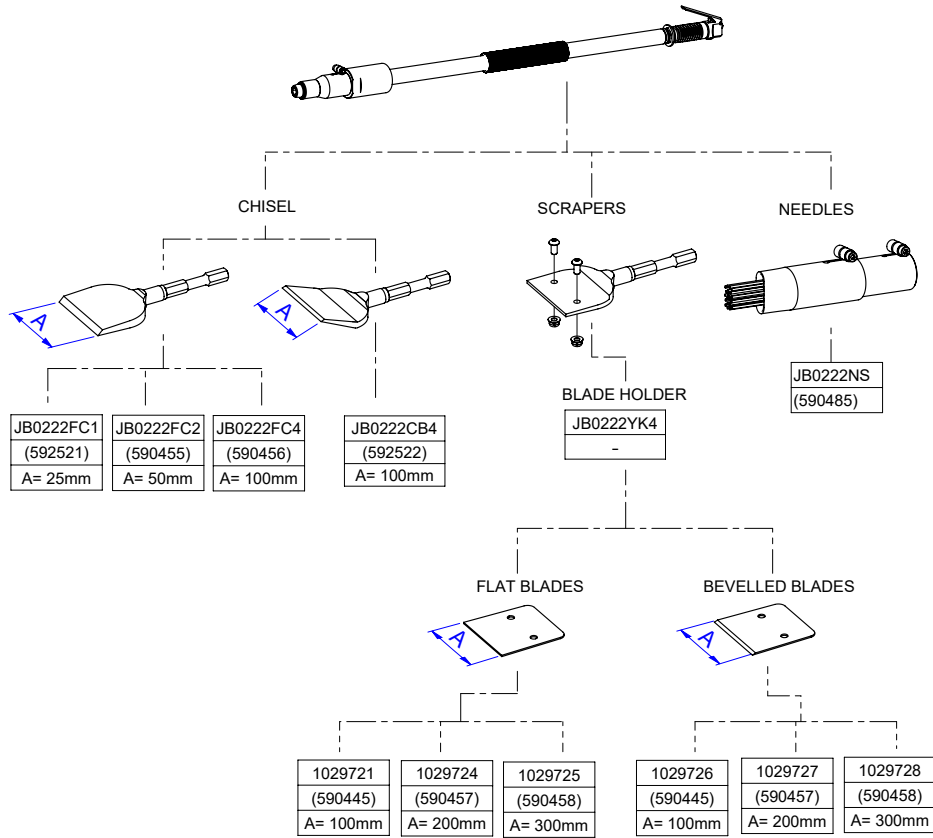

IMPA Code	Teryair Model No	Teryair Model No
Chisels mm (inch)		
592521	25 (1)	JB0222FC1
590455	50 (2)	JB0222FC2
590456	100 (4)	JB0222FC4
Chisel for Floor Tile Removal		
592522	100 (4)	JB0222CB4
Yoke Retainer with fasteners		
	100 (4)	JB0222YK4
Scrapers - Flat		
590445	100 (4)	1029721
590457	200 (8)	1029724
590458	300 (12)	1029725
Scrapers - Bevelled		
590445	100 (4)	1029726
590457	200 (8)	1029727
590458	300 (12)	1029728
Needle Attachment		
590485	-	JB0222NS

Teryair mucking winches are designed for extracting muck and sludge like deposits from tank floors. All capacities feature galvanized non spinning wire ropes. A worm wheel gear box multiplies torque and prevents load slippage even when not powered.

Features

- Galvanized non-spinning hoisting cable.
- Non sparking safety hook.
- Powerful air motor.

Applications

- For tank cleaning.



MCW100

MCW300

Technical data

IMPA Code	Teryair Model No	Lifting Capacity Kgs	Lifting	Wire Rope	Wire Rope	Air Hose Diam mm	Weight
			Speed (m/min)	Diameter mm	Length m		
590601	MCW100	50	35	4	33	15	62
590602	MCW100	75	35	4	33	15	62
590603	MCW100	100	30	4	33	15	62
590604	MCW200	150	25	4	40	19	64
590605	MCW200	200	30	4	40	19	64
590606	MCW300	250	20	4	40	19	69
590607	MCW300	300	30	4	40	19	69

Standard equipment included assembled

FRL unit, a forged hook, wire rope, forward and reverse valve, all hoses and connectors and air motor and gearbox. Neoprene rubber buckets are available as extras

IMPA number	Teryair Model Number	Standard Equipment
590601	MCW100	5665015, ½" FRL Unit, Wire Rope 33 meters
590602	MCW100	5665015, ½" FRL Unit, Wire Rope 33 meters
590603	MCW100	5665015, ½" FRL Unit, 5665005, Wire Rope 33 meters
590604	MCW200	5665015, ½" FRL Unit, Wire Rope 40 meters
590605	MCW200	5665015, ½" FRL Unit, Wire Rope 40 meters
590606	MCW300	5665015, ½" FRL Unit, Wire Rope 40 meters
590607	MCW300	5665015, ½" FRL Unit, Wire Rope 40 meters

Accessories and spares

10 Litre Neoprene Bucket, RB10 IMPA 590611

20 Litre Neoprene Bucket, RB20 IMPA 590612



Package dimensions and weights

Teryair Model No	Weight kgs	Box Dimensions cms
MCW100	72.0	79 x 79 x 201
MCW200	75.0	79 x 79 x 201
MCW300	85.0	79 x 79 x 201

Dimension drawing

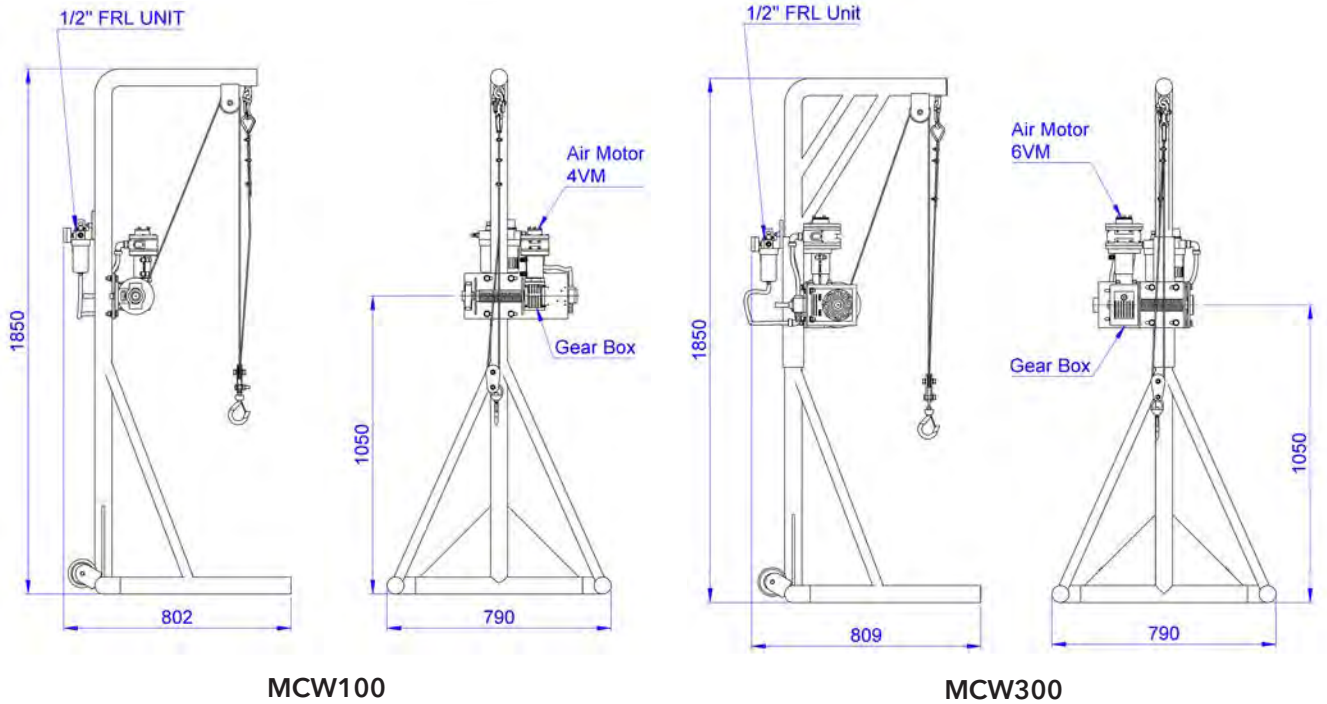

MCW100

MCW300

Teryair Vacuum Cleaners are compact and lightweight. These industrial vacuum cleaners work on compressed air and are capable of cleaning off water, oil and bottom sludge as well as dust and metal chipping. Their unique design permits the use of an ordinary pail or can with an outside diameter of 300mm to collect the dust and waste. Standard equipment includes a pail can, 2 meters of oil resistance hose, and an oil stopper which automatically stops suction when the receiver becomes full.

Features

- Automatic shut off when drum full.
- Lightweight and manoeuvrable.
- Compact industrial vacuum cleaner which works on compressed air.

Applications

- Used for cleaning up of water, oil, bottom sludge, dust, and metal chippings.



KLIN50

Technical data

IMPA Code	Teryair Model No	Hose	Suction Nozzle mm	Suction Nozzle ltr/min	Air Consumption m ³ /min	Suction Capacity at 5kgf/cm ² m ³
590722	KLIN-50	32 mm(dia) x 2 m	Ø32	500	3000 mm/H ₂ O	1.8

Standard equipment included

- Suction Pipe
- Nozzle
- Hose clip

Additional Data

Suction Force ltr/min
60- 80

Package dimensions and weights

Teryair Model No	Weight kgs	Box Dimensions cms
KLIN-50	7	38 x 34 x 57

Teryair Tank Cleaning Jets have twin nozzles and are durable and reliable tank washing machines. They have a Stainless Steel 316L construction combined with PEEK gears for durability and chemical resistivity. The two opposing nozzles continuously rotate in two axes and complete a complete cleaning cycle in approximately 20 minutes. Suitable for use with various cleaning media including water, crude oil and cleaning chemicals, both hot and cold. It is easily repairable on site and teryair spares are available widely.

Features

- Nozzles can be freely positioned to facilitate Usage in tight spaces.
- Choice of nozzles available depending on tank size.
- All chemical resistant materials used in construction.
- Self lubricating.
- 95 °C fluid handling capability.
- No cargo contamination.

Applications

- Suitable for use for washing / cleaning tanks in crude oil, chemical and product tankers.
- Suitable for washing / cleaning tanks in liquid port terminal tanks.
- Suitable for use in onshore process industry tanks.



TC110J

Certifications

- CE Certificate No CE 16831
- Lloyds Register Certificate of approval, No. LR2011185MC
- ATEX Codes
 Ⓜ II 2 GD Ex h IIC T6 Gb
 Ⓜ Ex h IIIC T85°C Db
- ATEX No - 2467/1/2023



Technical data

IMPA Code	590656
Teryair Model No	TC-110J
Nozzle Diameter mm	7-12
Water Consumption m ³ /Hr	8-23
Jet Length mtr	15-31
Washing Cycle min/Cycle	4-15
Working Pressure bar	5-12
Weight kgs	6.6

Package dimensions and weights

Teryair Model No	Weight kgs	Box Dimensions cms
TC-110J	10	39 x 25 x 32

Standard equipment included assembled

Part No.	Description
TC110-023N08	Set of 8 mm nozzles (2 pcs)

Accessories and spares

TC110-023N07	Set of 7 mm nozzles (2 pcs)
TC110-023N08	Set of 8 mm nozzles (2 pcs)
TC110-023N09	Set of 9 mm nozzles (2 pcs)
TC110-023N10	Set of 10 mm nozzles (2 pcs)
TC110-023N12	Set of 12 mm nozzles (2 pcs)

Dimension drawing

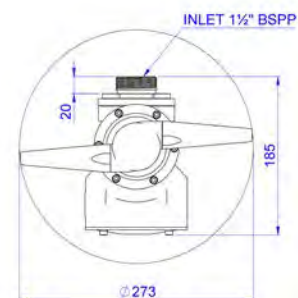
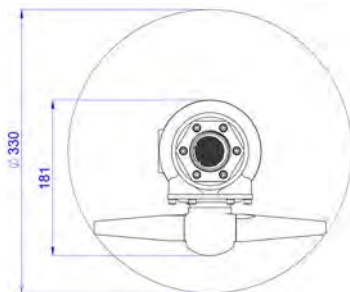
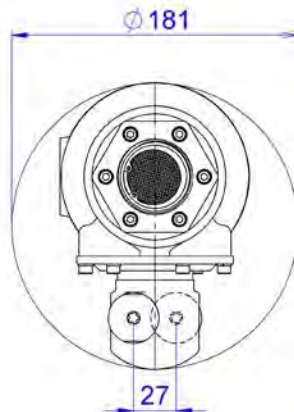
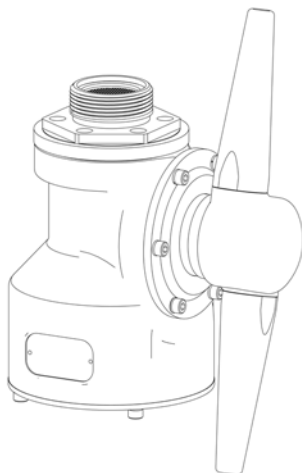

**Performance Graph
Inlet Pressure vs Discharge**

- Performance as measured discharging water at 20 °C.
- For guidance on how to select a suitable tank cleaning machine get in touch with teryair.
- Actual discharge performance may vary depending on cleaning media used, its viscosity and its density.

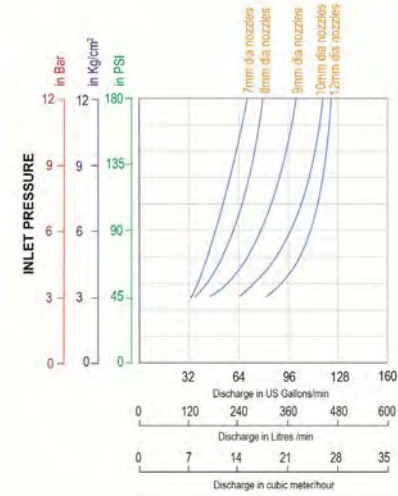

**Performance Graph
Inlet Pressure vs Jet Length**

- Performance as measured discharging water at 20 °C.
- For guidance on how to select a suitable tank cleaning machine get in touch with teryair.
- Actual Jet length may vary depending on cleaning media used, its viscosity and its density.

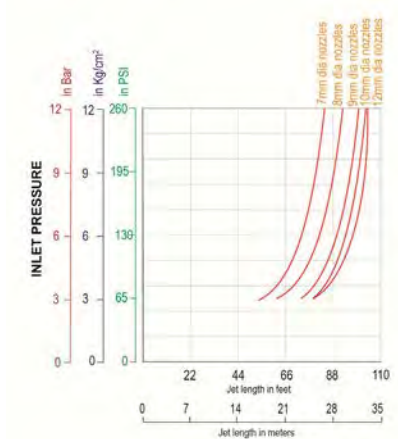

Nozzle Size	Inlet water Pressure (bars)	Flow (m³/hr)	Jet length (m)	Cycle time (min)
7	3	6	18	28
	5	10	22	26
	6	11	23	24
	8	12.5	25	22
	10	14	26.5	20
	12	15.5	27.5	18
8	3	9	20	26
	5	12.5	23.5	24
	6	13.75	25	22
	8	16.5	27	20
	10	17.75	28	18
	12	19.75	29	16
9	3	11	23	24
	5	15	25	22
	6	16.25	26	20
	8	18.75	28	18
	10	21.25	29	16
	12	22.5	30	14

10	3	14	26	22
	5	17.5	24	20
	6	18.75	27	18
	8	22	29	16
	10	24.5	30	14
	12	27	31	12
12	3	17	25	20
	5	18	26	18
	6	19.25	27.5	16
	8	22.5	29.5	14
	10	25	30.5	12
	12	27.5	31	10

Teryair Hold Cleaning Guns employ high pressure water jets, boosted by compressed air to remove loose flaking paint and cargo residue. Suitable for various sizes of holds and tanks, these Guns reduce potential contamination risks. Projects jets upto 30 meters. They are the preferred choice on bulk carriers and cargo vessels.

Features

- Cleans holds fast and effectively.
- Adjustable control valve provides suitable jet for the job at hand.
- Easily removes cargo residue, flaking paint and rust.
- No specialist operator skill or training required.
- Compact design.
- Low maintenance.

Applications

- Cargo hold cleaning.



HC50



HC63

Technical data

IMPA Code	590741	590742
Teryair Model No	HC-50	HC-63
Effective Jet Reach m	20-25	30
Working Pressure kgf/cm ²	5-7	7
Water Consumption	28 ton/hour	300 gal/min
Water Hose mm	50 or 65	50
Air Hose mm	15	19
Air Inlet inch	3/4 BSPP	3/4 BSPP
Material of Construction	Aluminum	Stainless Steel
Weight kgs	16	19

Package dimensions and weights

Teryair Model No	Weight kgs	Box Dimensions cms
HC-50	18.0	121 x 60 x 13
HC-63	21.0	121 x 60 x 13

Standard equipment included

HC-50		
Part no.	Description	Qty pcs
7541006	Coupling	1
7541007	Coupling	1
HC-63		
Part no.	Description	Qty
2500428	Coupling 2-1/2"	1
2500423	Coupling 2"	1

Dimension drawing

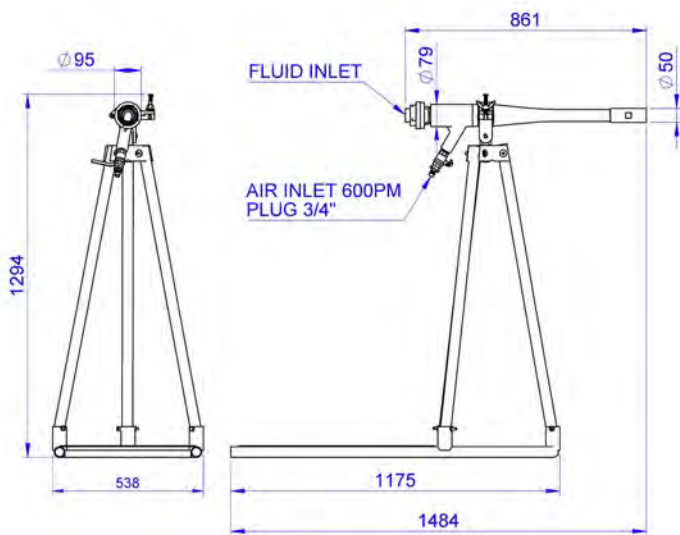

HC50

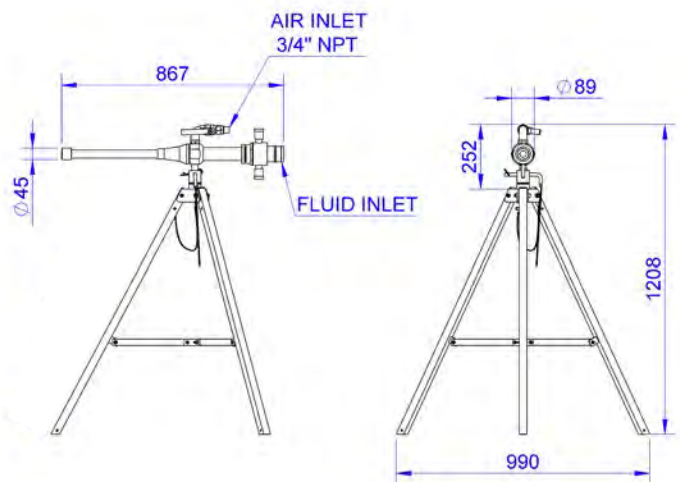

HC63

Teryair Pneumatically Operated High Pressure Cleaners are designed for heavy duty cleaning operations in hazardous environments.

Features

- Built in bypass safety valve.
- Durable low speed motor and pump unit.
- Atex certified air motor .
- Non corrosive materials in pump, fittings and pipes.
- 3 Ceramic fully coated pistons.
- Built in frl unit and muffler.
- Chemical injector.

Applications

These pneumatic heavy duty high pressure cleaners offer efficient cleaning, saving time and resources. Teryair pneumatic highpressure water jets are designed for general cleaning tasks in multiple industries. These high pressure water jets are used for daily cleaning of machinery, vehicles, and buildings, for the removal of stubborn dirt, stains and other debris from various surfaces.

Technical data

IMPA Code	590851
Teryair Model No	PW200
Power Consumption hp (kw)	9.0 (6.6)
Motor Speed rpm	1500
Working Pressure bar (psi)	200 (2900)
Flow Capacity ltrs/min	15
Max Air Consumption m ³ /hour (cf/min)	150 (330)
Air Inlet inch	1 BSPP
Dimension	762 x 572 x 585
Weight kgs	82.0

Standard equipment included

Description	Nos
FRL-25, 1" Filter , Regulator, Lubricator	1 pc
6379738, Discharge Hose 10mtr	1 pc
6379760, Nozzle Set of 5pcs	1 set
6379726, Water Inlet Hose	1 set
6379761, Gun with lance	1 set



PW200

Accessories and spares

6379765, Discharge Hose 15 mtr

6379750, Discharge Hose 50 mtr

Package dimensions and weights

Teryair Model No	Weight Kgs	Box Dimensions cms
PW-200	95.0	76 x 57 x 59

Dimension drawing

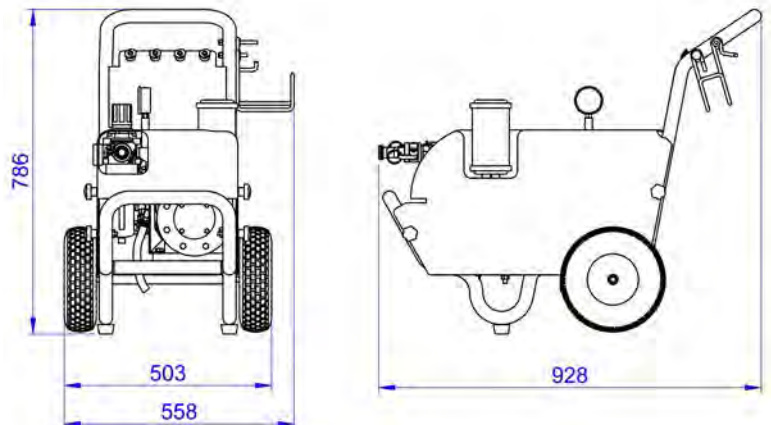

Features

- Auto bypass.
- Quick change tips.
- Adjustable output pressure.
- Ceramic coated pistons.
- Easy maintenance.

Applications

Teryair Electric High Pressure Cleaners are designed for general cleaning tasks in multiple industries. These high pressure cleaners are used for daily cleaning of machinery, vehicles, and buildings, for the removal of stubborn dirt, stains and other debris from various surfaces. All pump materials, fittings and pipes in contact with water are non corrosive.



Technical data

EW Series

IMPA Code	590857	590852	590853	590854	590855	590856	590853A	590854A
Teryair Model No	EW1103P-110V	EW1103P-220V	EW1706P-220V	EW1706P-440V	EW200-220V	EW200-440V	EW1106P-110V	EW1106P-220V
Power Supply	AC 110V 1 ph 60 Hz	AC 220V 1 ph 60 Hz	AC 220V 3 ph 60 Hz	AC 440V 1 ph 60 Hz	AC 220V 3 ph 60 Hz	AC 440V 3 ph 60 Hz	AC 110V 3 ph 60 Hz	AC 220V 3 ph 60 Hz
Power Consumption hp (kw)	3.0 (2.2)		6.0 (4.4)		7.5 (5.5)		3.0 (2.2)	
Motor Speed rpm	1750		1750		1750		1750	
Working Pressure bar (psi)	110 (1600)		170 (2470)		200 (2900)		110 (1600)	
Flow Capacity ltr/min	11.7		15.2		16.5		11.7	
Dimensions cms	75 x 59 x 61		75 x 59 x 61		86 x 61 x 61		75 x 59 x 61	
Weight kgs	60.0	60.0	65.0	65.0	74.0	74.00	55.0	55.0

Standard equipment included

Description	Nos
Gun with 500 mm Lance	1 pc
Nozzle set of 5 pcs	1 set
8mm x 10mtr High pressure hose	1 pc
Water Inlet Hose 11 mm x 2 mtr	1 pc

Accessories and spares

Description	Nos
8mm x 15 mtr High pressure hose	1 pc
8mm x 20 mtr High pressure hose	1 pc
8mm x 25 mtr High pressure hose	1 pc
8mm x 50 mtr High pressure hose	1 pc

Package dimensions and weights

Teryair Model No	Weight kgs	Box Dimensions cms
EW1103P-110V	65.0	75 x 59 x 61
EW1103P-220V	65.0	75 x 59 x 61
EW1106P-110V	65.0	75 x 59 x 61
EW1106P-220V	65.0	75 x 59 x 61
EW1706P-220V	65.0	75 x 59 x 61
EW200-220V	79.0	86 x 61 x 61
EW200-440V	79.0	86 x 61 x 61

Teryair Air Motors are Stall proof, Self Cooling, have a High Power to weight ratio, ATEX Explosion-proof, and Reversible - Thus making them the preferred choice for any of your applications. In many applications, the inherent features of air motors make them more suitable than electric or hydraulic options. Air Motors are used for mixing, lifting, and pulling applications in explosive zones. Speed and torque can be varied by simple modulation of input air

pressure and air volume. These air motors are suitable because of the many features that they exhibit. For example, these air motors are able to be loaded to the stall points without damage. Air motors can also tackle variable loads and are capable of being operated in environments where electrical motors are hazardous. An important feature of compressed air motors is their compact size as compared to electrical motors.

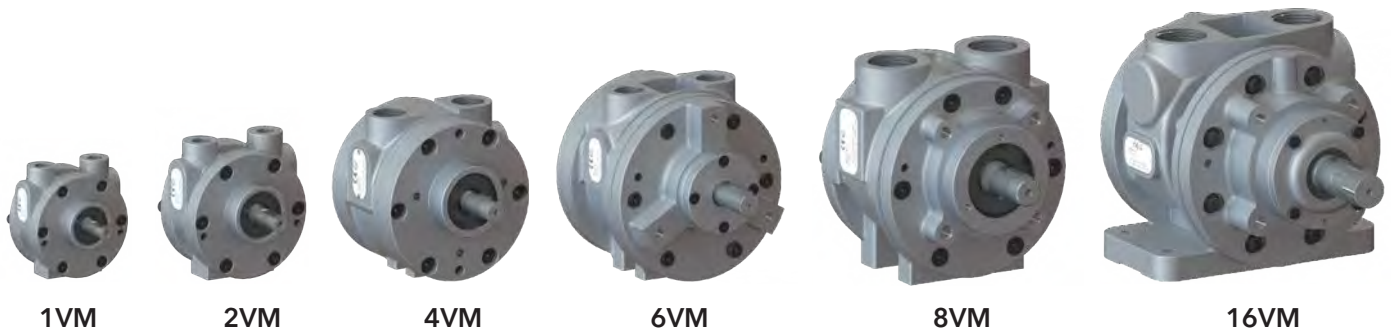

Technical data

IMPA Code	Teryair Model No	Output kW
Base Mount		
590965	1VMSALEXR	0.33
590966	2VMSALEXR	0.68
590967	4VMSALEXR	1.3
590968	6VMSALEXR	3.0
590969	8VMSALEXR	3.9
590970	16VMSALEXR	7.1
(IEC) Flange Mount		
590971	1VMDALEXR	0.33
590972	2VMDALEXR	0.68
590973	4VMDALEXR	1.3
590974	6VMDALEXR	3.0
590975	8VMDALEXR	3.9
590976	16VMDALEXR	7.1
Face Mount		
590977	1VMLALEXR	0.33
590978	2VMLALEXR	0.68
590979	4VMLALEXR	1.3
590980	6VMLALEXR	3.0
590981	8VMLALEXR	3.9
590982	16VMLALEXR	7.1

Features

- Cool Running
- Variable Speeds
- Load to Stall
- Instantly Reversible

Applications

- **Construction & machinery:** Concrete vibrators / hose & cable feeders / pipe cutting & threading.
- **General machinery:** Multiple uses such as mixers and agitators power-driven tumblers, barrels, indexing tables, paint finishing equipment.
- **Environmental:** Air ventilation & ducting fans.
- **Valve operating:** Actuation of valves.
- **Lifting applications:** Mucking winches, pneumatic chain hoist.
- **Conveyors:** Material handling & automatic material movement through the driver chain. Safe use in hazardous atmosphere in chemical industries.

Standard equipment included

Muffler

Accessories and spares

Part No.	Description
8119702	Repair kit for 1VM Motors
8039701	Repair kit for 2VM Hub/Foot Type Motors
8039702	Repair kit for 2VM IEC/NEMA Type Motors
8049701	Repair kit for 4VM Face/Foot Type Motors
8049702	Repair kit for 4VM IEC/NEMA Type Motors
8059701	Repair kit for 6VM Face/Foot Type Motors
8059702	Repair kit for 6VM IEC/NEMA Type Motors
8069701	Repair kit for 8VM Face/Foot Type Motors
8069702	Repair kit for 8VM IEC/NEMA Type Motors
8109701	Repair kit for 16VM Face/Foot Type Motors

See more



For more information, please download our detailed technical brochure for this product here. [Teryair Air Motor Family Brochure](#)

These drills are used for all conventional drilling of steel or wood.

Features

- Low vibration.
- High power to weight ratio.

Applications

- For light and medium duty drilling.



ED Series

Standard equipment included

- Chuck key.
- Carbon brush.

Technical data

AC 110V Single Phase			AC 220V Single Phase		
IMPA Code	Teryair Model No	Drilling Capacity mm	IMPA Code	Teryair Model No	Drilling Capacity mm
591002	ED100-110V	10.0	591012	ED100-220V	10.0
591003	ED130-110V	13.0	591013	ED130-220V	13.0
591004	ED160-110V	16.0	591014	ED160-220V	16.0

Package dimensions and weights

Teryair Model No	Weight kgs	Box Dimensions cms
ED100-110V	2.0	36 x 24 x 7
ED130-110V	2.5	36 x 24 x 7
ED160-110V	4.5	28 x 28 x 12
ED100-220V	2.0	36 x 24 x 7
ED130-220V	2.5	36 x 24 x 7
ED160-220V	4.5	28 x 28 x 12

Teryair Electric Angle Grinders are used for continuous heavy duty work for all grinding applications.

Features

- Lightweight for easy manoeuvring.
- Variety of accessories offers multipurpose usage.



AG Series

Applications

- Sanding
- Rough grinding
- Removal of rust, paint from metal surfaces

Standard equipment included

- Wheel spanner
- Carbon brush handle

Technical data

AC 110V Single Phase			AC 220V Single Phase		
IMPA Code	Teryair Model No	Wheel mm	IMPA Code	Teryair Model No	Drilling Capacity mm
591021	AG4E-110V	100	591021	AG4E-220V	100
591022	AG5E-110V	125	591022	AG5E-220V	125
591023	AG6E-110V	150	591023	AG6E-220V	150
591024	AG7E-110V	180	591024	AG7E-220V	180

Package dimensions and weights

Teryair Model No	Weight Kgs	Box Dimensions cms
AG4E-110V	1.5	36 x 24 x 7
AG5E-110V	2.5	36 x 24 x 7
AG6E-110V	4.0	36 x 24 x 7
AG7E-110V	6.0	53 x 15 x 18
AG4E-220V	1.5	36 x 24 x 7
AG5E-220V	2.5	36 x 24 x 7
AG6E-220V	4.0	36 x 24 x 7
AG7E-220V	6.0	53 x 15 x 18

Teryair Electric Needle Scalers are rugged tools designed to be easy to use and maintain. They are ideal for removing layers of paint, corrosion and chemical coatings from surfaces. Rotating handle can be fixed at any position to make operation easier.

Features

- Quick change needles.
- Robust and lightweight.

Applications

- Removal of coatings.
- Hold cleaning, general deck and surface cleaning.
- Paint removal of heavy rust on tankers and dry dock applications .
- Tank descaling, descaling of structures prior to painting.
- Other industrial coating removal from floors and other surfaces.
- Weld cleaning.

Technical data

IMPA Code	591201	591203
Teryair Model No	ENS100V	ENS200V
Power Supply	AC100V 50/60 Hz	AC230V 50/60 Hz
Power Consumption W	900	900
Rated Current A	3.2	1.4
Stroke Speed	3000 min ⁻¹	3000 min ⁻¹
Needle	3mm x 23pcs 2mm x 53pcs	3mm x 23pcs 2mm x 53pcs
Power cord length m	2	2

Standard equipment included

Teryair Model No	Part no.
ENS100V, ENS200V	0224045 Needle Supporter 3mm - 1 pc
	0229004OL 3mm x 180mm Needle - 23 pcs
	0224052 Hose nipple -1 pc
	0229039 Allen key - 1 pc
	Carbon Brush - 1 pair
	Spanner - 1 no.
	Allen Key - 1 no.
	Universal Industrial Socket - 1 no.



ENS Series

Accessories and spares

See needles on the page 37

Spare Needles for Needle Scalers, suits all brands of Needle Scalers/Jet Chisels

Package dimensions and weights

Teryair Model No	Weight kgs	Box Dimensions cms
ENS100V	10.0	48 x 14 x 37
ENS200V	10.0	48 x 14 x 37

Features - Electric

Teryair Electric Machines are lightweight electric scaling machines for continuous heavy duty use. An ideal unit for derusting and descaling jobs. Portable, fitted with wheels. Furnishable for use with a 110 volt or 220 Volt AC power supply.

Technical data

IMPA Code	591217	591218
Teryair Model No	TEFD75-110V	TEFD75-220V
Voltage	110V	220V
H. P.	0.75	0.75
kW	0.55t	0.55
No load speed r'pm	3700	3700
Weight kgs	35.0	35.0



TEFD75

Features - Pneumatic

Teryair Pneumatic Scaling Machines are light and easy to handle, but rigidly constructed tools for efficient heavy duty scaling. Required air pressure is 0.59 Mpa (6 kgf/cm2)

Technical data

IMPA Code	591251
Teryair Model No	TPFD75
Max Air Consumption m ³ /min	0.8
No load speed rpm	5000
Weight kgs	21.0

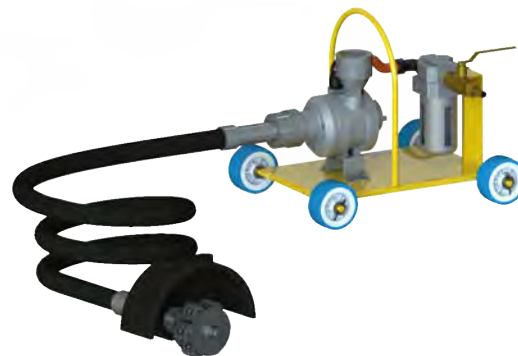

TPFD75

Standard equipment included

Teryair Model No	Nos
TEFD75-110V	59.12.55 No. 1 HD Tool - 1 pc 59.12.60 No. 2 LG Brush - 1 pc 59.12.66 No. 4 HammerHead - 1 pc
TEFD75-220V	59.12.73A Wire Wheel Brush Assembly - 1pc 34229733 Flexible Shaft 2 meter
TPFD75	59.12.55 No. 1 HD Tool - 1 pc 59.12.60 No. 2 LG Brush - 1 pc 59.12.66 No. 4 HammerHead - 1 pc L12 1/2" Lubricator - 1pc 8059801 Muffler - 1pc 804000 Air Motor Size 4 - 1 pc 3349728 Flexible Shaft 2 meter





















Package dimensions and weights

Teryair Model No	Weight kgs	Box Dimensions cms
TEFD75-110V	40.0	44 x 37 x 60
TEFD75-220V	40.0	44 x 37 x 60
TPFD75	25.0	44 x 37 x 60

Accessories and spares

Image	IMPA Code	Teryair Part No	Description
	59.12.53	3429733	Flexible Shaft 2 mtr for Electric Descalers
		3429747	Flexible Shaft 3 mtr for Electric Descalers
		3349728	Flexible Shaft 2 mtr for Pneumatic Descaler
		3349731	Flexible Shaft 3 mtr for Pneumatic Descaler

Accessories and spares

Images	IMPA Code	Description	Illustration	Application
	59.12.55	No. 1 HD Tool	Assembly	Heavy Rusting
	59.12.56	No. 1-1 Cutter	18 pcs/set	For HD Tool
	59.12.57	No. 1-2 Disc Pin	6 pcs/set	For HD Tool
	59.12.58	No. 1-3 Centre Bolts & Nut	Assembly	For HD Tool
	59.12.59	No. 1-4 Disc	2 pcs/set	For HD Tool
	59.12.60	No. 2 LG Brush	Assembly	Light Rusting
	59.12.61	No. 2-1 LG Blade	72 pcs/set	For LG Brush
	59.12.62	No. 2-2 Disc Pin	6 pcs/set	For LG Brush
	59.12.63	No. 2-3 Centre Bolts & Nut	Assembly	For LG Brush
	59.12.64	No. 2-4 Disc	2 pcs/set	For LG Brush
	59.12.65	No. 3 Cup Brush	Assembly	Light Rusting
	59.12.66	No. 4 Hammerhead	Assembly	Wide Rusting
	59.12.67	No. 4-1 Hammer Blade	12 pcs/set	For Hammer Head
	59.12.68	No. 4-2 Disc Pin	3 pcs/set	For Hammer Head
	59.12.69	No. 4-3 Center Bolt & Nut	Assembly	For Hammer Head
	59.12.70	No. 4-4 Disc	2 pcs/set	For Hammer Head
	59.12.71	No. 4-5 Collar	Assembly	For Hammer Head
	59.12.72	Washer	15 pcs/set	For Hammer Head
	59.12.73	No. 5 Wire Wheel Brush		Finishing
	59.12.74	No. 6 Grindstone		Grinding

Dimension drawing

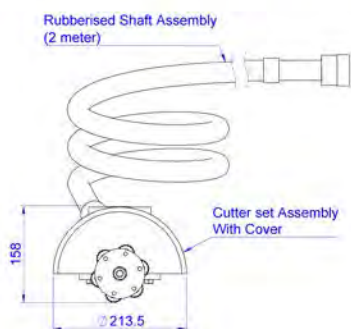
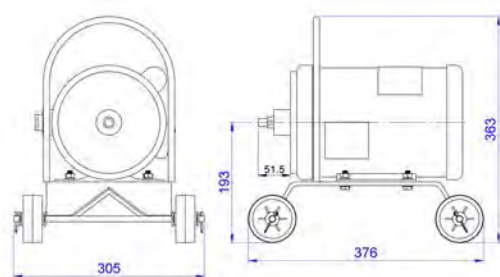

TEFD75

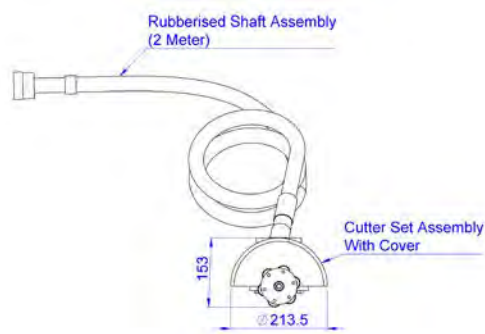
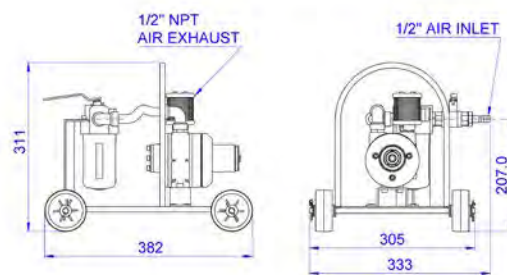

TPFD75

Teryair Ventilation Fans are highly efficient and portable. They provide ventilation of gas, paint fumes and other hazardous fumes. These fans' ideal bell mouth type casing is highly efficient, creates little noise and it is easy to install an air duct. Air ducts are available as separate accessories.

Features

- ATEX air motor on pneumatic versions.

Applications

Ventilation fans with flexible ducts are versatile tools that find numerous applications in various industries and settings. Here are some common uses of ventilation fans with flexible ducts:

- **Confined Space Ventilation:** In confined spaces such as tanks, tunnels, or underground areas, ventilation fans with flexible ducts are used to circulate fresh air, ensuring a safe and breathable environment for workers.
- **Industrial Ventilation:** In manufacturing facilities and industrial settings, ventilation fans help remove fumes, dust, and harmful airborne particles, maintaining a clean and safe working environment.
- **Construction Sites:** Ventilation fans are employed at construction sites to remove dust, smoke, and exhaust gasses, improving air quality and worker safety.
- **Disaster Recovery and Cleanup:** During disaster recovery and cleanup operations, ventilation fans with flexible ducts are used to clear out smoke, dust, and debris, aiding in rescue efforts and facilitating safe cleanup processes.



Electric - VF Series



Pneumatic - PVF Series

- **Paint Booth Ventilation:** In automotive and painting industries, ventilation fans are utilized to exhaust paint fumes and maintain proper air circulation within paint booths, ensuring a safe working environment.
- **Event Cooling and Air Circulation:** In outdoor events or temporary structures, ventilation fans are employed to provide cooling and improve air circulation, enhancing the comfort of attendees.
- **Hazardous Material Handling:** In industries dealing with hazardous materials, ventilation fans help control and remove dangerous vapors and fumes to safeguard workers and the environment.
- **Emergency Response:** Ventilation fans are used in emergency response situations, such as firefighting operations, to control smoke and create escape routes for occupants.
- **Mining:** In mining operations, ventilation fans with flexible ducts are utilized to provide fresh air to underground mines, ensuring a safe and breathable environment for miners.

Technical data - Pneumatic

IMPA Code	Teryair Model No	Case Diameter mm	Capacity m3/hr
591425	PVF-300	305	3566
591426	PVF-400	405	8665

Standard equipment included

Teryair Model No	Teryair Model No
PVF300	8015001, ½" Filter, Regulator, Lubricator Unit - 1pc
PVF400	8080801 Silencer - 1pc

Additional Data

IMPA Code	Teryair Model No	Air Inlet inch	Air inlet supply kg/cm ²	rpm	Weight kgs
591425	PVF-300	½ BSPP	6	3000	9.0
591426	PVF-400	½ BSPP	6	3600	11.0

Package dimensions and weights

Teryair Model No	Weight kgs	Box Dimensions cms
PVF300	10.0	46 x 44 x 44
PVF400	12.0	52 x 29 x 52

Technical data - Electric

IMPA Code	Teryair Model No	Case Dia mm	Phase	IMPA Code	Teryair Model no	Case Dia mm	Phase
AC 100 Volt ± 10%				AC 200 Volt ± 10%			
591402	VF200-110V	200	Single	591406	VF200-220V	200	Single
				591407	VF300-220V	300	Single
591403	VF300-110V	300	Single	591408	VF400-220V3	400	Triple
				591409	VF500-220V3	500	Triple

Additional data

Teryair Model No	VF200-110V	VF200-220V	VF300-110V	VF300-220V	VF400-220V / 220V3	VF400-440V	VF500-220V / 220V3	VF500-440V
Casing Dia mm	200	200	300	300	400	400	500	500
Electric Source	110V 1P	220V 1P	110V 1P	220V 1P	220V 1P / 220V 3P	440V 3P	220V 1P / 220V 3P	220V 3P
Air Volume m ³ /min	20	20	70	70	110	110	190	190
Pressure mm Aq	25	25	25	25	50	50	70	70
rpm	3000	3600	3000	3600	3000	3600	3000	3600
Output	0.16 kw	0.16 kw	0.55 kw	0.55 kw	1.5 kw	1.5 kw	3.7 kw	3.7 kw
Weight kgs	9.5	9.5	15.0	15.0	28.0	28.0	34.5	34.5

Technical data - Explosion Proof - Electric

IMPA Code	591416	591417	591418	591419
Teryair Model No	SVF200-110V	SVF200-220V	SVF300-110V	SVF300-220V
Casing Dia mm	200	200	300	300
Voltage	AC-100 V	AC-200V	AC-100 V	AC-200V
Phase	Single	Single	Single	Single
RPM	3000	3600	3000	3600
Air Volume m ³ /min	20	20	70	70
Pressure	25 mm Aq	25 mm Aq	30 mm Aq	30 mm Aq
Weight kgs	13.0	13.0	17.0	17.0



**Explosion Proof - Electric
SVF Series**

Package dimensions and weights

Teryair Model No	Weight kgs	Box Dimensions cms	Teryair Model No	Weight kgs	Box Dimensions cms
VF300-110V	17.00	43 x 40 x 40	SVF200-110V	14.0	35 x 29 x 38
VF200-220V	11.00	35 x 29 x 38	SVF300-110V	19.0	43 x 40 x 40
VF300-220V	17.00	43 x 40 x 40	SVF200-220V	14.0	35 x 29 x 38
VF400-220V3	30.00	53 x 50 x 48	SVF300-220V	19.0	43 x 40 x 40
VF500-220V3	37.00	64 x 60 x 49			

Teryair Flexible Ventilation Tubes are made of PVC tarpaulin canvas. A lightweight, highly flexible duct ideal for improving the efficiency of blowers especially in confined areas. When ordering, Specify type of tube and length required.

Ventilation Tubes

Part no.	Description
59.14.81	Ventilation Tube 200mm x 5mtr
59.14.82	Ventilation Tube 200mm x 10mtr
59.14.83	Ventilation Tube 300mm x 5mtr
59.14.84	Ventilation Tube 300mm x 10mtr
59.14.85	Ventilation Tube 400mm x 5mtr
59.14.86	Ventilation Tube 400mm x 10mtr

Teryair Explosion Proof Ventilation Tubes are made of nylon tarpaulin with earth grip.

Ventilation Tubes

Part no.	Description
59.14.21	Ventilation Tubes for Explosion Proof 200 mm x 5 meter
59.14.22	Ventilation Tubes for Explosion Proof 300 mm x 5 meter



**Electric & Pneumatic
Ventilation Tubes**



**Electric - Explosion Proof
Ventilation Tubes**

Teryair Water Turbine Fans / Water Driven Gas Freeing Fans are designed for ventilation of gasses from large enclosed areas or other tank openings. They work effectively, providing penetration deep into the tank ensuring complete ventilation. Teryair fans are made of a non spark construction with a stainless steel 316 impeller and integral water motor. The components are manufactured from corrosion proof material.

Features

- Precise manufacturing of ss impeller & pelton wheel generates a higher air flow.
- Aluminum blades for durability.

Applications

- High performance ventilation of gasses from large enclosed areas.
- Ventilation of tanks which requires a deep penetration.

Technical data

IMPA Code	591436	591437
Teryair Model No	WTF-300	WTF-400
Outlet Bore Dia mm	300	400
Capacity m³/min	70-220	100-290
Water Pressure kgf/cm²	1-7	1-7
Water Consumption m³/hr	20-43	24-48
Hose Dia mm	50	50
Weight kgs	26.0	40.0

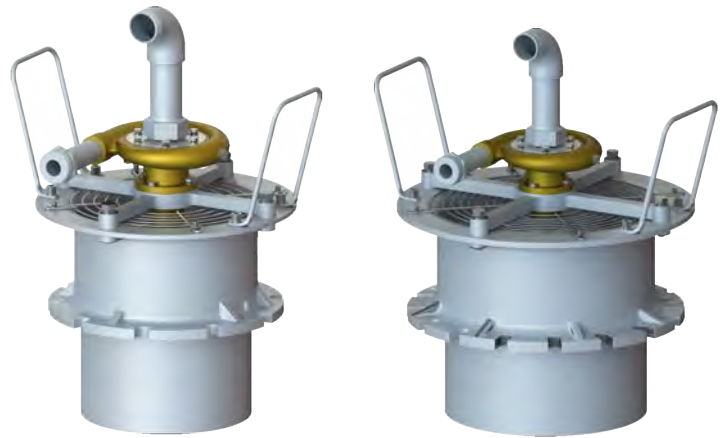

WTF300

WTF400

Standard equipment included

- 2" BSP (F) x 2" BSP (M) Elbow- 90°, 1 no.
- 2" BSP (M) x 1-1/4" BSP (M) Inlet Pipe, 1 no.
- 2" BSP (F) x 2" BSP (M) Outlet Pipe, 1 no

Package dimensions and weights

Teryair Model No	Weight kgs	Box Dimensions cms
WTF-300	28.00	50 x 48 x 48
WTF-400	42.00	61 x 61 x 49

Dimension drawing

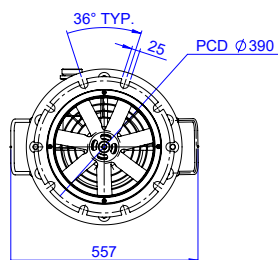
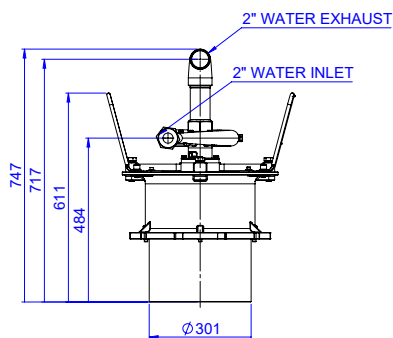

WTF300

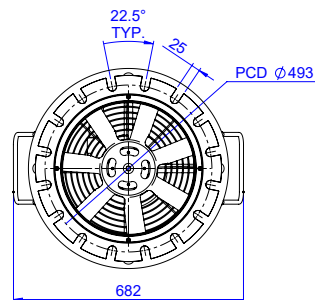
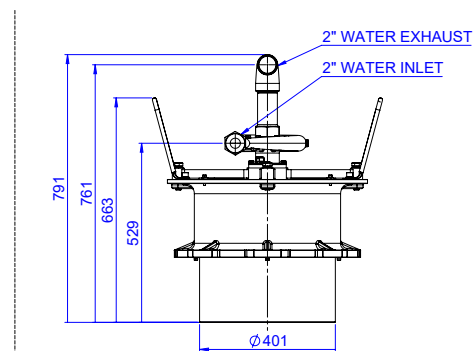

WTF400

Teryair Compressed Air Driven Fans are used for efficient drying and ventilating of large areas in tankers and other vessels. These fans are turbine driven by compressed air.

Features

- ATEX air motor with filter, regulator and lubricator built in.
- Aluminum fan blades for durability.

Applications

- High performance ventilation of gasses from large enclosed areas.
- Ventilation of tanks which requires a deep penetration.

Technical data

IMPA Code	591446	591447
Teryair Model No	PTF-300	PTF-400
Outlet Bore Dia mm	300	400
Capacity m ³ /min	130	210
Recommended Air Pressure bar (psi)	6.2 (90)	6.2 (90)
Air inlet & Outlet inch	1/2 NPT	1/2 NPT
Hose Dia mm	50	50
Weight kgs	30.0	40.0



PTF300

PTF400

Standard equipment included

PTF-300	PTF-400
6VMLALEXR - Air Motor - 1 pc	
8015001 FRL Unit - 1pc	

Package dimensions and weights

Teryair Model No	Weight kgs	Box Dimensions cms
PTF-300	32.0	46 x 44 x 44
PTF-400	42.0	52 x 29 x 52

Dimension drawing

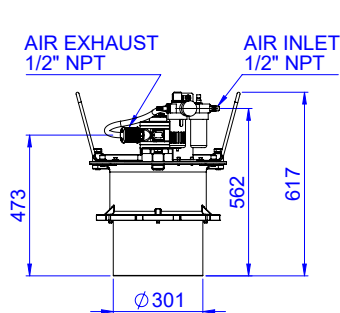

PTF300

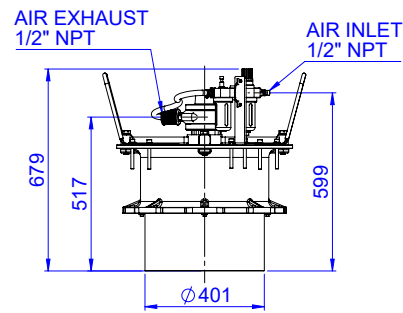

PTF400

Teryair air operated diaphragm pumps have state of the art features such as lube free anti-stall valves. They offer a wide range of diaphragm options that give you a more practical and budget friendly options. They deliver a top-notch performance. Supported by strong no nonsense warranties and easy pricing on spares, Teryair Metal AODD pumps are quickly gaining market share in many markets.

All Teryair AODD pumps are ATEX explosion proof and CE Certified. Our pumps are equivalent in performance to popular brands.

Aluminum Diaphragm Pumps - Applications and Technical Data

Aluminum pumps main feature is their portability due to the light weight to pumping capacity. Ideal for pumping of water and water based fluids. Non aggressive fluids, oily fluids and fluids having low acidic or alkali concentrations are also well handled.

Features

- Handling of viscous fluids, slurries, solid laden fluids and shear sensitive fluids.
- No priming needed.
- Robust construction is conducive to all weather outdoor use.

New Bolted Versions Available From Nov 2023 *



IMPA Code		591605	591601	591602	591603	591604
Teryair Model No		DP12ALN	DP25ALN	DP40ALN	DP50ALN	DP75ALN
Standard Casing		Aluminum				
Suction Lift	Wet inch	31	31	28	31	31
Air Inlet BSPT/NPT/BSPP		1/4" Hose nipple (Barb)	1/4"	1/2"	3/4"	3/4"
Water	Inlet BSPT/NPT/BSPP inch	1/2	1	1-1/2	2	3
	Outlet BSPT/NPT/BSPP inch	1/2	1	1-1/4	2	3
Size	Height inch	9.24	11	17.4	26.3	31.9
	Width inch	4.91	10.5	15.4	15.9	17.0
	Depth inch	8.06	7.3	11.2	13.5	11.0
Weight Kgs		4.00	10.0	15.0	27.0	47.0
Air Valve Replacement Kit NPT/BSPT/BSPP		1719741	1639703/ 1639704/ 1639705	1519703/ 1519704/ 1519705	2029703/ 2029704/ 2029705	2119711/ 2119712/ 2119713
Repair Kit		1719752	1639706N	1519706N	2029706N	2119710N

For more information, please download our detailed technical brochure for this product here. [Teryair AODD Pump Family Brochure](#)

See more



Polypropylene Diaphragm Pumps - Applications and Technical Data

Polypropylene pumps or PP pumps are lower in cost to the Stainless Steel pumps and can be a suitable alternative in a majority of the applications. However, in applications which need high temperatures or outdoor rough environments, Stainless Steel is still preferred. These pumps are usually combined with PTFE. With these elastomers, they are ideal for pumping of fluids like benzyl, di-acetone, phosphoric acid, ferric sulfate, isopropyl chloride, transformer oils and many other similar fluids.

These pumps find wide applications across industries, some popular ones being Chemicals, Pharma and Electronic manufacturing.

Technical Specs In Detailed Technical Brochure*



IMPA Code		591611	591612	591613	591614
Teryair Model No		ADPB12PPT	ADPB25PPT	DPB40PPT	SDP50PPTB
Standard Casing		Polypropylene			
Suction Lift	Wet inch	28	29	26	31
Air Inlet BSPT/NPT/BSPP inch		3/8	1/4	1/2	3/4
Water	Inlet BSPT/NPT/BSPP inch	1/2	1	1-1/2	2
		Female	ANSI Flange	Female	ANSI Flange
	Outlet BSPT/NPT/BSPP inch	1/2	1	1-1/4	2
		Female	ANSI Flange	Female	ANSI Flange
Size	Height inch	8.6	14	20.8	30.3
	Width inch	8.2	11.6	15.5	19.3
	Depth inch	8.0	9.1	11.2	13.1
Weight kgs		2.70	13.00	10.55	29.00
Air Valve Replacement Kit NPT/BSPT/BSPP		1739704	6129711/ 6129712/ 6129708/	6259737	2039701
Repair Kit		1739702	6129707	6259719	2039705

For more information, please download our detailed technical brochure for this product [here](#). [Teryair AODD Pump Family Brochure](#)

See more



Stainless Steel Diaphragm Pumps - Applications and Technical data.

Stainless Steel pumps are used where there is a demand for high pumping performance, combinations of both hot and corrosive fluids, both acidic and alkali. They are the ultimate choice for durable long life performance.

Teryair offers some leading diaphragm materials in combination with these pumps to tackle some of the most difficult pumping applications.

New Bolted Versions Available From Nov 2023*



DP25SST



DP40SST

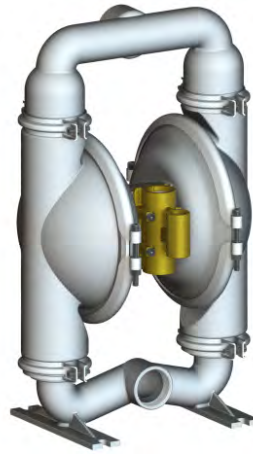

DP50SST

IMPA Code	591701	591703	591706
Teryair Model No	DP25SST	DP40SST	DP50SST
Description	1" Pump	1-1/2" Pump	2" Pump
Central Section Material	Aluminum		
Connection Thread	BSP/NPT/BSPT	BSP/NPT/BSPT	BSP/NPT/BSPT
Wetted Material	Stainless Steel		
Seat Material	Stainless Steel		
Ball Material	PTFE		
Diaphragm Material	PTFE		
Max Flow GPM (LPM)	33 (125)	70 (263)	155 (586)
Max Operating Pressure psi (bar)	120 (8.3)	120 (8.3)	120 (8.3)
Max Solids Inches (mm)	1/8 (3.2)	3/16 (4.8)	1/4 (6.4)
Air Inlet NPT/BSPT/BSPP inch	1/4	1/2	3/4
Weight kgs	13.60	23.20	42
Air Valve Replacement Kit NPT/BSPT/BSPP	1639703 / 1639704 / 1639705	1519703 / 1519704 / 1519705	2029703 / 2029704 / 2029705
Repair Kit	1639706ST	1519706ST	2029706ST

For more information, please download our detailed technical brochure for this product [here](#). [Teryair AODD Pump Family Brochure](#)

See more



Package dimensions and weights

Teryair Model No	Weight kgs	Box Dimensions cms
------------------	------------	--------------------

Aluminum Pump Series

DP12ALN	5.00	23 x 15 x 26
DP25ALN	11.00	32 x 26 x 39
DP40ALN	17.00	38 x 32 x 50
DP50ALN	29.00	43 x 37 x 71
DP75ALN	50.00	50 x 43 x 86

Polypropylene Pump Series

ADPB12PPT	3.50	24 x 17 x 30
ADPB25PPT	14.00	52 x 30 x 57
DPB40PPT	12.00	27 x 36 x 53
SDP50PPTB	31.00	53 x 36 x 71

Stainless Steel Pump Series

DP25SST	16.00	34 x 27 x 45
DP40SST	26.00	48 x 32 x 67
DP50SST	45.00	58 x 35 x 82

For more information, please download our detailed technical brochure for this product [here](#).

[Teryair AODD Pump Family Brochure](#)

See more



Teryair Pneumatic Sump Pumps / Centrifugal Pumps are used to empty ballast tanks, bilge wells and similar applications. Often used for draining cargo holds during and after the washing procedure. Teryair sump pumps have a small cross-section and hence can be lowered into areas having small access hatches. Especially preferred where an eclectic spark may risk ignition or explosion. Required air pressure is 059 MPa (6 kgf/cm²).

Features

- Will pump down to 22mm will handle up to 3mm solids.
- Governor controlled motor.
- Compact design enables use in restricted areas.

Applications

- Transfer of fluids, usage in sumps for periodic dewatering.
- Emptying ballast tanks, after washing procedure.
- Draining cargo holds during and after the washing procedure.
- Pumping of sea water from bilges, holds, etc.
- Also used in the construction, dewatering and engineering industry.

Technical data

IMPA Code	Teryair Model No	Capacity		Max. Air Consumption m ³ /min	Water Hose Size inch	Air Hose Size inch	Weight kgs
		Total Head m	discharge m ³ /h				
591635	SP-10	25	28	2.7	2	3/4	21
591636	SP-10	25	28	2.7	2	3/4	21
591637	SP-25	22	38	3.5	2-1/2	3/4	32



SP10

SP25

Standard equipment included

Teryair Model No	Description
SP-10	1999750 Gate Valve - 1 pc 1992109 Discharge Nipple - 1c
SP-25	1999750 Gate Valve - 1 pc 1902128 Discharge Nipple - 1pc

Package dimensions and weights

Teryair Model No	Weight Kgs	Box Dimensions cms
SP-10	22.0	31 x 25 x 45
SP-25	32.0	10 x 75 x 120

Accessories and spares

1999753 Repair Kit for SP-10

1909711 Repair Kit for SP-25

Additional data - Performance graphs

Head vs Discharge at 90 psi air supply pressure.

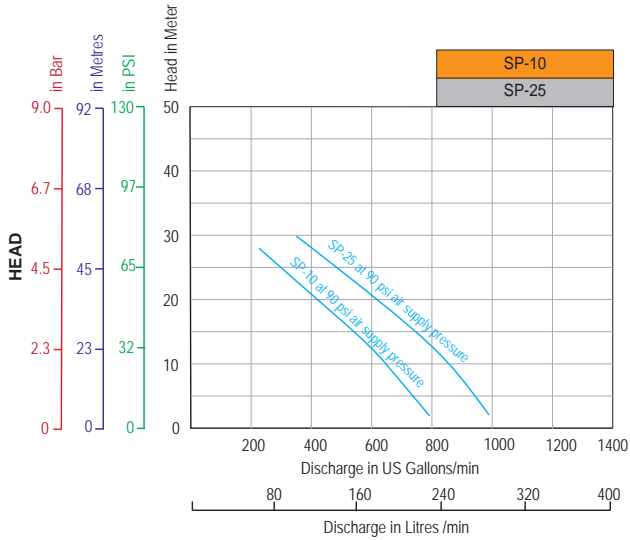

SP10 / SP25

Dimension drawing

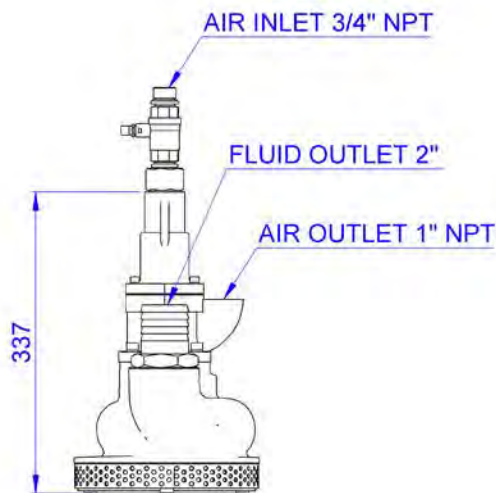
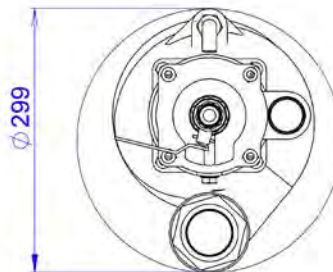
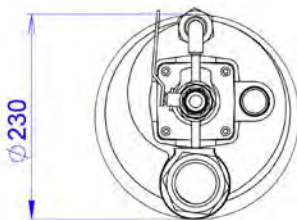

SP10

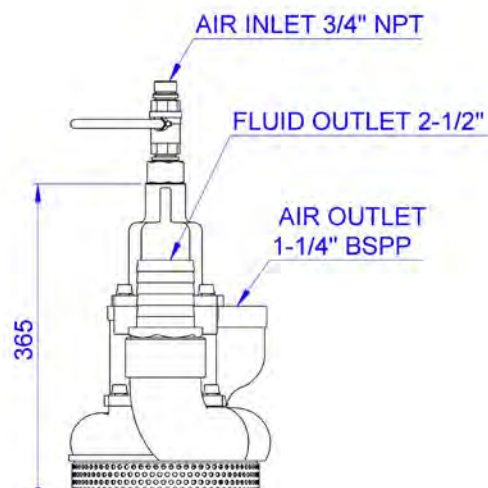

SP25

Teryair Pneumatic Barrel (Drum) Pumps are ideally suited for transferring light oils from barrels. They can be directly inserted into a barrel and screwed onto the bung by means of the provided adaptor. They can be inserted into most barrels and operate over a range of air inlet pressures.

Features

- Bung adaptor fits most barrels.
- Will operate over a range of air inlet pressures.

Applications

- General transfer of fluids out of barrels.

Technical data

IMPA Code	591653
Teryair Model No	BP-10
Discharge Pressure kgf/cm ²	0.55
Hose	32 mm x 3 mtr

Standard equipment included

2982102 Hose Nipple 1/4" NPT - 1pc
2982108 Hose Nipple 3/4" NPT - 1pc



BP10

Additional data

Air Inlet inch	1/4 NPT
Fluid Outlet inch	3/4 NPT
Air Consumption m ³ /min	0.27
Tube Diameter mm	55
Air Supply psi	80-90
External Body	Plated steel
Weight kgs	5.3

Accessories and spares

2980014K Repair kit for BP10

Package dimensions and weights

Teryair Model No	Weight kgs	Box Dimensions cms
BP-10	7.0	10 x 7 x 120

Performance graphs

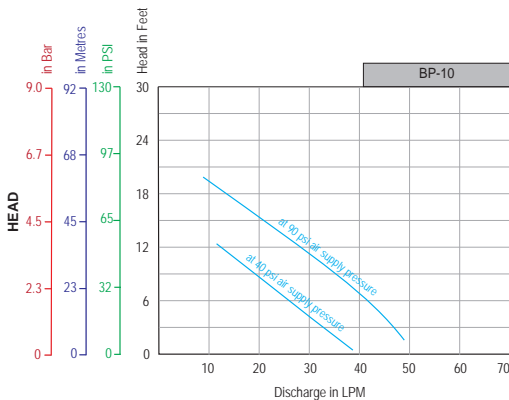

BP10

Dimension drawing

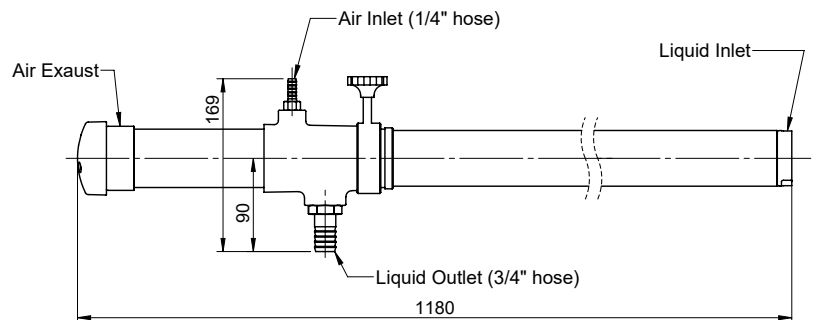

Teryair Pneumatic Airless Paint Sprayers are used for marine applications, hence have tough fittings. They include specially treated chrome stainless steel rods and cylinders which can withstand heavy wear and tear. They operate over a longer span of time even when used for pumping highly abrasive or corrosive materials.

Features

- Easily replacement filters.
- Consistent spray pressure.
- Easy to adjust output pressure.
- Variety of hose lengths, guns and spray available for Different spray applications.
- Easy to clean and maintain.

Applications

- High - pressure airless spraying machines are intended to use for the spraying of new coatings Or thick - film, heavy - duty anti-corrosive coatings which are difficult to operate.
- This machine is used in industrial departments such as steel structures, ships, automobiles, railway Vehicles and so on.
- Solutions for residential, commercial or Industrial jobs.

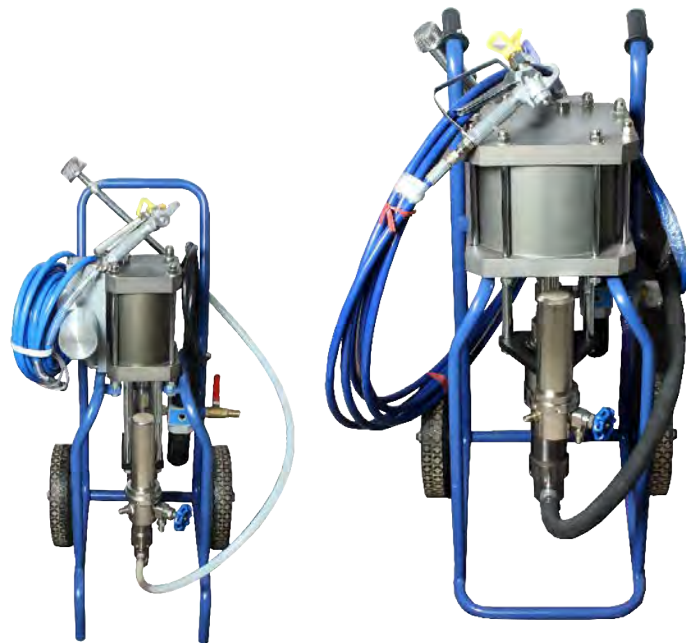

PPS04

PPS11

Technical data

IMPA Code	270106	270107	270108
Teryair Model No	PPS-02	PPS-04	PPS-11
Pump Ratio	23:1	30:1	40:1
Max flow ratio ltr/min	2	4	11
Max Air work pressure MPa (kgf /cm²)	0.7 (7)		
Air Consumption N ltr/cycle	4-5	11-14	68-75
Weight kgs	32.00	32.00	52.50
Air Hose Connection inch	½ BSPP	½ BSPP	½ BSPP
Paint Hose connection	¼" BSP	¼" BSP	½" BSP

Standard equipment included

- 1 Meter paint suction hose.
- 15 Meter paint delivery hose, 6mm id, nylon reinforced, 3300 Psi.
- 1/2" Bsp filter regulator lubricator unit.
- 5 Meter air inlet hose, 16mm id, pvc reinforced, 200 psi .
- Gun complete with tip 517.
- Spare seal kit.
- Maintenance tools kit.
- Frame with wheels.

Package dimensions and weights

Teryair Model No	Weight Kgs	Box Dimensions cms
PPS-02	35.50	56 x 57 x 77
PPS-04	35.50	56 x 57 x 77
PPS-11	59.50	65 x 66 x 107

Teryair Airless Paint Spray Hand Guns are available in three sizes.

Technical data

IMPA Code	270121	270123
Teryair Model No	HGS03	HGS2.3
Max work pressure MPa (bar)	24.8 (248)	
Inlet Size	1/4 NPSM (F)	
Orifice Diameter mm	3.2	2.3



Teryair Paint Spray Pole Guns increases comfort, speed, and productivity needed to spray hard to reach areas without using ladders or scaffolding.

Technical data

IMPA Code	270126	270127	270128
Teryair Model No	PGS-09	PGS-18	PGS-24
Length mm	900	1800	2400
Inlet Size	1/4 NPSM (F)		

Package dimensions and weights

Teryair Model No	Weight Kgs	Box Dimensions cms
PGS-09	4.00	97 x 13 x 13
PGS-18	4.50	188 x 13 x 13
PGS-24	6.50	249 x 13 x 13



Pole Guns

Teryair High pressure Nylon Paint Spray Hoses are made of PVC material which is strengthened with stainless steel braided wire. These hoses are durable but lightweight and flexible.



Technical data

IMPA Code	Teryair Part No	Length m	ID mm	Work Pressure Max kgf/cm ²	Coupled with
270161	4590161	10	6	230	1/4 NPSM (F)
270162	4590162	15			
270163	4590163	20			
270164	4590164	30			
270165	4590165	10	9	230	3/8 NPSM (F)
270166	4590166	15			
270167	4590167	20			
270168	4590168	30			

Paint mixers are used to mix paint, ink, and other coatings. Speed can be adjusted easily depending on the intensity of mixing needed. Pneumatic powered mixers are safe for use in explosive zones. Teryair paint mixers are lightweight and durable machines designed for outdoor environments.

Technical data

IMPA Code	Teryair Model No	Capacity ltr	rpm	Air Inlet inch
270581	27.05.81	40	500	1/4 BSPP
270582	27.05.82	200	500	1/4 BSPP

Package dimensions and weights

Teryair Model No	Weight Kgs	Box Dimensions cms
27.05.81	5.00	58 x 10 x 9
27.05.82	13.00	54 x 42 x 17



Paint Stirrers

Teryair High Pressure Airless Spray Tips improves spraying productivity. Saves time no screwdriver required. Change tip sizes in seconds - without removing the tip guard housing. Locking tab ensures the tip stays securely in guard. For heavy-duty applications. The most common



Technical data

IMPA Code	Teryair Model No	Tip Model No	Orifice Size inch	Pattern (Fan) Width mm (inch)	Flow Rate GPM	Flow Rate LPM
270911	ST 15/4	415	0.015		0.24	0.91
270912	ST 17/4	417	0.017		0.31	1.17
270913	ST 19/4	419	0.019	No - 4 203-254 (8-10)	0.38	1.47
270914	ST 21/4	421	0.021		0.47	1.79
270915	ST 23/4	423	0.023		0.57	2.15
270916	ST 25/4	425	0.025		0.67	2.54
270921	ST 13/5	513	0.013	No - 5 254 - 305 (10 ~ 12)	0.18	0.69
270922	ST 15/5	515	0.015		0.24	0.91
270923	ST 17/5	517	0.017		0.31	1.17
270924	ST 19/5	519	0.019		0.38	1.47
270925	ST 21/5	521	0.021		0.47	1.79
270926	ST 23/5	523	0.023		0.57	2.15
270927	ST 25/5	525	0.025		0.67	2.54
270931	ST 13/6	613	0.013	No - 6 305 - 356 (12 ~ 14)	0.18	0.69
270932	ST 15/6	615	0.015		0.24	0.91
270933	ST 17/6	617	0.017		0.31	1.17
270934	ST 19/6	619	0.019		0.38	1.47
270935	ST 21/6	621	0.021		0.47	1.79
270936	ST 23/6	623	0.023		0.57	2.15
270937	ST 25/6	625	0.025		0.67	2.54

Teryair Rubber Air Hoses are made from superior quality materials. They have multiple braids and have a tough outer layer to tackle abrasion. They are suited for general use and available in different sizes.



Technical data

IMPA Code	Nominal Size	Actual Size mm		Braid	Working Pressure kgf/cm ²	Meter per Coil
		I.D	O.D			
350101	6	6.3	14.5	1 B	15	50
350102	9	9.5	14.5			50
350103	12	12.7	17.2			50
350104	15	15.9	20.5		10	50
350105	19	19.0	25.0			50
350106	25	25.4	38.0			50
350107	32	31.8	47.0		1 B	7

Teryair Water Rubber Hoses are high quality hoses designed to withstand being dragged over any surface. They are also resistant to deterioration from weather and sunlight. They are provided with an extra heavy tube cover and cotton duck carcass. Recommended for high pressure service.



Technical data

IMPA Code	Nominal Size	Actual Size mm		Braid	Working Pressure bar	Weight Per m/gram	Meter per Coil
		I.D	O.D				
350155	25	25.4	35.5	1B	4	760	30
350156	32	31.8	43.0			1060	
350158	38	38.1	50.0			1360	

Teryair Hose Couplings have Female thread connections for use with the ship's male thread air outlet. They are made of cast brass.

Technical data

IMPA Code	Teryair Model No	Nominal Size mm	Connection Thread
350151	35.01.51	6	M42 x 2
350152	35.01.52	8	M42 x 2
350153	35.01.53	9	M42 x 2
350154	35.01.54	12	M42 x 2
350155	35.01.55	15	M42 x 2
350156	35.01.56	19	M42 x 2
350157	35.01.57	25	M42 x 2



Teryair manufactures a range of Pneumatic Line couplers in Brass, Stainless Steel and Steel. Fluids such as compressed air and water are compatible with Teryair Quick Connect Couplers. Select Brass, (Code BR) for lower pressure and very frequent connect/disconnect operations. Select SS 304, (Code SS) for use in marine atmosphere and for use with water and compressed air. Select Carbon Steel, (Code CS) for only compressed air operation.

Features

- Precision machined.
- Automatic shut off.
- Hardened wear parts.
- Nitrile rubber seals.

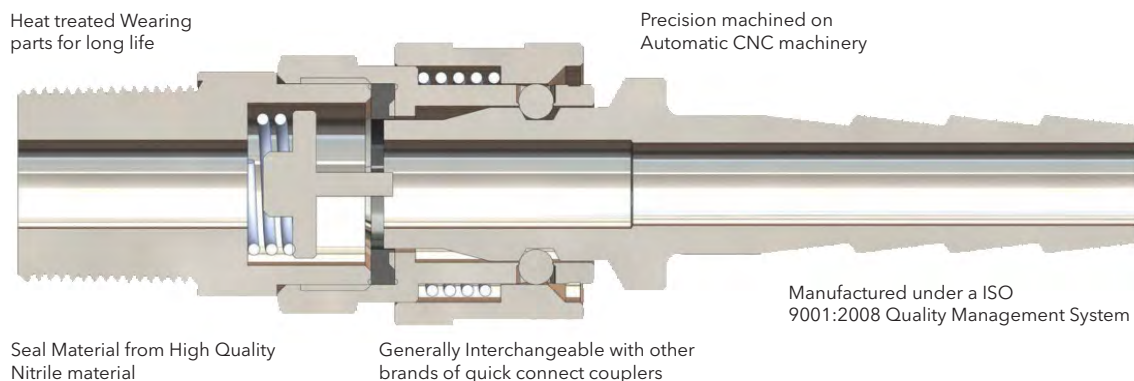

- Flow in CFM through teryair small series couplers are from 40 cfm to 70 cfm at 6 bar pressure.
- Flow in CFM through teryair large series couplers are from 105 cfm to 192 cfm at 6 bar pressure.
- Max pressure allowable in brass is 10 kg/cm².
- Max pressure allowable in steel and SS is 15 kg/ cm².
- Flow direction is always from Socket to Plug .
- Generally compatible with other brands of quick connect couplers.

Technical data

Hose End Type

Hose End Size	Part no.	Steel IMPA Code	Stainless Steel IMPA Code	Brass IMPA Code
---------------	----------	--------------------	------------------------------	--------------------

SH Series Socket

1/4	20 SH	351201	351211	351221
3/8	30 SH	351202	351212	351222
1/2	40 SH	351203	351213	351223
1/2	400 SH	351204	351214	351224
3/4	600 SH	351205	351215	351215
1	800 SH	351206	351216	351226

PH Series Socket

1/4	20 PH	351231	351241	351251
3/8	30 PH	351232	351242	351252
1/2	40 PH	351233	351243	351253
1/2	400 PH	351234	351244	351254
3/4	600 PH	351235	351245	351255
1	800 PH	351236	351246	351256



SH Series Socket



PH Series Socket

Male Thread Type

Hose End Size	Part no.	Steel IMPA Code	Stainless Steel IMPA Code	Brass IMPA Code
---------------	----------	--------------------	------------------------------	--------------------

SM Series Socket

1/8	10 SM	351301	351321	351311
1/4	20 SM	351302	351322	351312
3/8	30 SM	351303	351323	351313
1/2	40 SM	351304	351324	351314
1/2	400 SM	351305	351325	351315
3/4	600 SM	351306	351326	351316
1	800 SM	351607	351327	351317

PM Series Socket

1/8	10 PM	351331	351351	351341
1/4	20 PM	351332	351352	351342
3/8	30 PM	351333	351353	351343
1/2	40 PM	351334	351354	351344
1/2	400 PM	351335	351355	351345
3/4	600 PM	351336	351356	351346
1	800 PM	351337	351357	351347



SM Series Socket



PM Series Socket

Female Thread Type

Hose End Size	Part no.	Steel IMPA Code	Stainless Steel IMPA Code	Brass IMPA Code
SF Series Socket				
1/4	20 SF	351401	351421	351411
3/8	30 SF	351402	351422	351412
1/2	40 SF	351403	351423	351413
1/2	400 SF	351404	351424	351414
3/4	600 SF	351405	351425	351415
1	800 SF	351406	351426	351416
PF Series Socket				
1/4	20 PF	351431	351451	351441
3/8	30 PF	351432	351452	351442
1/2	40 PF	351433	351453	351443
1/2	400 PF	351434	351454	351444
3/4	600 PF	351435	351455	351445
1	800 PF	351436	351456	351446



SF Series Socket



PF Series Socket

Teryair Double End Shut Off Couplers are double path switching type couplers having automatic valve mechanism at both the socket & the plug. Both are sealed instantly on disconnection. A variety of packing materials is permitted according to the type of fluid.



Hose End Size	Part no.	Steel IMPA Code	Stainless Steel IMPA Code	Hose End Size	Part no.	Steel IMPA Code	Stainless Steel IMPA Code
S Series Socket				P Series Socket			
1/8	1S	351501	351521	1/8	1P	351531	351551
1/4	2S	351502	351522	1/4	2P	351532	351552
3/8	3S	351503	351523	3/8	3P	351533	351553
1/2	4S	351504	351524	1/2	4P	351534	351554
3/4	5S	351505	351525	3/4	5P	351535	351555
1	6S	351506	351526	1	6P	351536	351556
1-1/4	10S	351507	351527	1-1/4	10P	351537	351557
1-1/2	12S	351508	351528	1-1/2	12P	351538	351558
2	16S	351509	351529	2	16P	351539	351559

Teryair Line Couplers and Star Couplers are used for simultaneous connection of multiple hose to a single air supply source. Available in Steel and Stainless Steel

Technical data - Line Couplers

IMPA Code	Teryair Part No	Type	Body Mounting		Accessory Socket
351653	35.16.53	200L	20 SM (1/4) x 4	400 PM (1/2) x 1	400 SH (1/2) x 1
	35.16.53SS		40 SM (1/2) x 1		



Technical data - Star Couplers

IMPA Code	Teryair Part No	Body Mounting		Accessory Socket
		Socket	Plug	
351651	35.16.51	20 SM (1/4) x 4	400 PM (1/2) x 1	400 SH (1/2) x 1
	35.16.51SS	40 SM (1/2) x 1		



Teryair Punching Tool / Table set is ideal for quickly punching holes in gaskets. It is lightweight and easy to handle. It can be easily used on any workbench. The punches are hardened and can be easily re-ground to retain the cutting edge.

Technical data

IMPA Code	Teryair Part No	Type mm	Body Mounting
613056	PX-1	6 - 38	16 pcs punching dies (6,7,8,9,10,11,12,13,16,19,22,25,28,32,35,38)



Package dimensions and weights

Teryair Model No	Weight kgs	Box Dimensions cms
PX-1	11.0	24 x 23 x 23

Standard accessories

- 16 pcs punching dies (6,7,8,9,10,11,12,13,16,19,22,25,28,32,35,38)

Teryair Grease Lubricators meet the highest standards of quality and come in a powder coated finish with all the external components nickel plated for longer life. They are provided with castors for easy mobility and a swivel arrangement which makes them easily manoeuvrable. The anti-lock pressure plates ensure easy flow of grease.

Technical data

IMPA Code	617501	-	-
Teryair Model No	GP-20	GP-25	GP-50
Pump Ratio	65:1	50:1	50:1
Max. Output Pressure MPa	45.5	55.15	55.15
Max. Outlet Quantity g/min	320	350	350
Grease Capacity kgs	16 - 18	25	50



GP-50

GP-25

GP-20

Package dimensions and weights

Teryair Model No	Weight kgs	Box Dimensions cms
GP-20	15.0	42 x 42 x 78
GP-25	22.0	41 x 28 x 91
GP-50	38.5	65 x 66 x 107

Spur-Gear Chain Hoists are made up of specially heat treated and proof tested steel chain hoists equipped with a safety guard. These hoists can be operated at any angle and are equipped with a slip bolt which allows easy replacement of the load chains. The load wheel operates on a precision ball bearing which is sealed with lubrication inside to eliminate the adverse effect of particles and dust on the moving parts. The top, bottom hooks, and the cross head are drop forged and the bottom hook is a swivel type to allow easy turning at the bottom of the load. These hoists have superior working capacities.

Technical data

IMPA Code	Teryair Model No	Capacity in Tons	Standard Lift m	Required Hand Power kgs	Weight kgs
615006	61.50.06	1/2	2.5	30	11.0
615007	61.50.07	1	2.5	35	13.0
615008	61.50.08	1-1/2	2.5	38	19.0
615009	61.50.09	2	3	39	28.0
615010	61.50.10	3	3	45	38.0

Package dimensions and weights

Teryair Model No	Weight kgs	Box Dimensions cms
61.50.06	7.50	24 x 23 x 23
61.50.07	7.50	24 x 23 x 23
61.50.08	10.5	24 x 23 x 23
61.50.09	11.5	28 x 28 x 24
61.50.10	20.0	36 x 30 x 28



Non Spark Chain Hoist are specially designed for LNG-LPG vessels and tankers, use in areas that may have exposure to explosion risk. These are made of non sparking copper alloys material except for the gears which are tightly covered by copper alloy casing assuring no-sparking during operation.

Technical data

IMPA Code	Teryair Model No	Capacity in Tons	Tested Capacity Ton	Weight kgs
615021	61.50.21	0.5	0.75	15.9
615022	61.50.22	1	1.5	35.2
615023	61.50.23	2	3	44.0
615024	61.50.24	3	4.75	65.0

Package dimensions and weights

Teryair Model No	Weight kgs	Box Dimensions cms
61.50.21	9.50	24 x 23 x 23
61.50.22	10.0	24 x 23 x 23
61.50.23	18.5	24 x 23 x 23
61.50.24	22.5	28 x 28 x 24



Teryair Valve Seat Cutting Tools are easy to use. They are easy to assemble and can handle precision cutting work.

Technical data

IMPA Code	Teryair Model No	Description
633451	VS-1	Valve Seat Cutter 1" - 4"



Standard accessories

- 1", 2", 3" and 4" cutters.

Package dimensions and weights

Teryair Model No	Weight kgs	Box Dimensions cms
VS-1	6.0	38 x 11 x 9

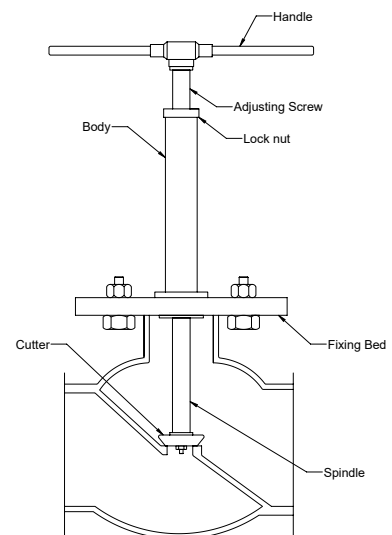

Teryair Pneumatic Safety Lamps are used for lighting in hazardous areas. Continuous output of high quality general illumination is produced by these lamps by providing suitable air supply.

Applications

- Oil and Petrochemical Industries.
- Tank ships & Tank cleaning & pipeline inspection.



TSL-50AF

TSL-50AB

Technical data

IMPA Code	330637	330638
Teryair Model No	TSL-50AF	TSL-50AB
Beam Type	Flood Light	Bay Light (All-around 3600 illumination)
Lens	Toughened glass (15mm)	Ball Glass / Plastic Dome
Area of Classification	Zones 1 & 2, Gas groups IIA, IIB	
Ambient Temperature	-20 °C to +40 °C	
Enclosure	Nickel plated brass and gun-metal	
Light Source Type	Tungsten Halogen Filament Bulb	
Volts	24	
Watts	250	
Output lumens	6000 (at 24 Volt)	
Air Pressure bar	4.0 - 8.0	
Consumption m ³ /min	0.75	
Weight kgs	7.0	7.0

Standard accessories

- Halogen Bulb

Package dimensions and weights

Teryair Model No	Weight kgs	Box Dimensions cms
TSL-50AF	8.00	34 x 30 x 39
TSL-50AB	8.00	34 x 30 x 39

Teryair Scupper Plug for sealing the scupper holes for spilled oil or polluted liquids. Easy to use, insert plug in the drain hole and tighten the handle until a slight resistance is felt, the rubber plug will be expanded drain pipe diameter when ordering, referring to the plug application list.



Technical data

Scupper plugs with brass plates

IMPA Code	Teryair Model No	Dimensions mm				Weight kgs
		d	D	l	L	
232481	23-24-81	42	65	55	156	0.490
232482	23-24-82	49	75	55	156	0.490
232483	23-24-83	62	85	65	156	0.560
232484	23-24-84	85	110	65	156	0.900
232485	23-24-85	90	115	65	156	0.950
232486	23-24-86	110	135	65	156	1.150
232487	23-24-87	132	160	65	156	1.400
232488	23-24-88	165	200	74	156	2.158

Package dimensions and weights

Teryair Model No	Weight kgs	Box Dimensions cms
232481	0.7	115x90x165
232482	0.7	115x90x165
232483	1.0	115x90x165
232484	1.2	120x120x195
232485	1.3	120x120x195
232486	1.5	145x145x170
232487	2.0	160x160x175
232488	2.5	210x210x180

Scupper plugs with plastic plates

IMPA Code	Teryair Model No	Dimensions mm				Weight kgs
		d	D	l	L	
232481	23-24-81PB	42	65	55	156	0.400
232482	23-24-82PB	49	75	55	156	0.450
232483	23-24-83PB	62	85	65	156	0.500
232484	23-24-84PB	85	110	65	156	0.600
232485	23-24-85PB	90	115	65	156	0.650
232486	23-24-86PB	110	135	65	156	0.700
232487	23-24-87PB	132	160	65	156	0.800
232488	23-24-88PB	165	200	74	156	1.100

Package dimensions and weights

Teryair Model No	Weight kgs	Box Dimensions cms
23-24-81PB	0.6	115x90x165
23-24-82PB	0.7	115x90x165
23-24-83PB	0.7	115x90x165
23-24-84PB	0.8	120x120x195
23-24-85PB	0.9	120x120x195
23-24-86PB	1.1	145x145x170
23-24-87PB	1.2	160x160x175
23-24-88PB	1.5	210x210x180

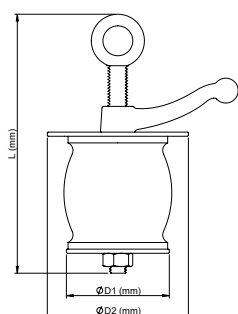

Dimensional Data

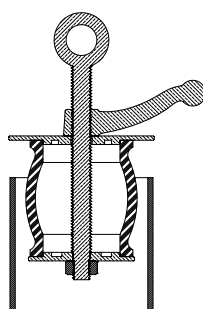

Un expanded in pipe

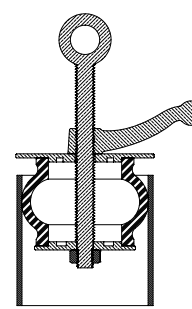

Expanded in pipe



Teryair Equipment Pvt Ltd

A1- Tirupati Udyog Nagar, Sativali Road,
Vasai East, Maharashtra 401208, India.
M: +91 744 7400 655 / +91 887 903 2775
E : info@teryair.com
W: www.teryair.com

